TECHNICAL MANUAL

GENERAL SUPPORT MAINTENANCE REPAIR PARTS AND SPECIAL TOOLS LISTS

(INCLUDING DEPOT MAINTENANCE REPAIR PARTS AND SPECIAL TOOLS)

FOR

AN/ARM-92 AND AN/ARM-92A

HEADQUARTERS, DEPARTMENT OF THE ARMY

APRIL 1973

DEPARTMENT OF THE ARMY TECHNICAL MANUAL

General Support Maintenance Repair Parts and Special Tools List
 (Includes Depot Maintenance Repair Parts and Special Tools)

FOR
 TEST SETS, RADIO
 AN/ARM-92 AND AN/ARM-92A

Headquarters, Department of the Army, Washington, D.C.

15 April 1973

Current as of 15 November 1972

	Paragraph	Page
SECTION I. INTRODUCTION		1
Scope	1	1
General	2	1
Explanation of columns	3	1
Special information	4	2
How to locate repair parts.	5	2
Federal supply code	6	3
Recommendations for maintenance publication improvements	7	4
II. REPAIR PARTS FOR DS, GS, AND DEPOT MAINTENANCE		5
III. INDEX - FEDERAL STOCK NUMBER AND REFERENCE NUMBER CROSS-REFERENCE TO FIGURE AND REFERENCE DESIGNATION		21
IV. INDEX - REFERENCE DESIGNATION CROSS-REFERENCE TO PAGE NUMBER		29

This manual supersedes Appendix B (DS, GS, and Depot Repair Parts) of TM 11-6625-820-45, 22 September 1966.

SECTION I

INTRODUCTION

1. Scope.

This manual lists repair parts and special tools required for the performance of direct support, general support, and depot level maintenance of the AN/ARM-92 and AN/ARM-92A.

2. General.

This Repair Parts and Special Tools List is divided into the following sections:

a. Repair Parts - Section II. A list of repair parts authorized for the performance of maintenance at the direct support, general support, and depot level.

b. Federal Stock Number and Reference Number Index - Section III. A list of Federal stock numbers in ascending numerical sequence followed by a list of reference numbers (Manufacture P/N) in ascending alpha-numeric sequence, cross-referenced to the illustration figure number and reference designation.

c. Reference Designation Cross-Reference to Page Number Index - Section IV. A list of reference designation numbers in alpha-numeric sequence, cross-referenced to page number of the Repair Parts List.

3. Explanation of columns.

The following provides an explanation of columns in the tabular lists in Section II.

a. Source, Maintenance and Recoverability Codes (SMR), Column 1.

(1) Source code indicates the selection status and source for the listed item. Source codes are:

<u>Code</u>	<u>Explanation</u>
<u>P</u>	- applies to repair parts that are stocked in or supplied from the GSA/DSA, or Army supply system, and authorized for use at indicated maintenance categories.
<u>M</u>	- applies to repair parts that are not procured or stocked, but are to be manufactured at indicated maintenance categories.
<u>A</u>	applies to assemblies that are not procured or stocked as such, but are made up of two or more units, each of which carry individual stock numbers and descriptions, and are procured and stocked and can be assembled by units at indicated maintenance categories.
<u>X</u>	- applies to parts and assemblies that are not procured or stocked; the mortality of which

normally is below that of the applicable end item; and the failure of which should result in retirement of the end item from the supply system.

XI - applies to repair parts which are not procured or stocked, the requirement for which will be supplied by the use of the next higher assembly or component.

X2 - applies to repair parts which are not stocked. The indicated maintenance category requiring such repair parts will attempt to obtain them through cannibalization; if not obtainable through cannibalization, such repair parts will be requisitioned with supporting justification through normal supply channels.

C - applies to repair parts authorized for local procurement. If not obtainable from local procurement, such repair parts will be requisitioned through normal supply channels with a supporting statement of nonavailability from local procurement.

G - applies to major assemblies that are procured with PEMA funds for initial issue only to be used as exchange assemblies at DSU and GSU level. These assemblies will not be stocked above DSU and GSU level or returned to depot supply level.

(2) Maintenance code indicates the lowest category of maintenance authorized to install the listed item. The maintenance level code is:

<u>Code</u>	<u>Explanation</u>
<u>C</u>	- Crew or operator maintenance
<u>O</u>	- Organizational maintenance
<u>F</u>	- Direct Support maintenance
<u>H</u>	- General Support maintenance
<u>D</u>	- Depot maintenance

(3) Recoverability code indicates whether unserviceable items should be returned for recovery on salvage. Items not coded are expendable. Recoverability codes are:

Code	Explanation
R	- applies to repair parts and assemblies which are economically repairable at DSU and GSU activities, and normally are furnished by supply on an exchange basis.
S	repair parts and assemblies which are economically repairable at DSU and GSU activities, and normally are furnished by supply on an exchange basis. When items are determined by a DSU to be uneconomically repairable, they will be evacuated to a depot for evaluation and analysis before final disposition.
T	- applies to high dollar value recoverable repair parts which are subject to special handling and are issued on an exchange basis. Such repair parts normally are repaired or overhauled at depot maintenance activities.
V	- applies to repair parts specifically selected for salvage by reclamation units because of previous metal content, critical materials, high dollar value reusable casings or castings.

b. Federal Stock Number, Column 2. This column indicates the Federal stock number assigned to the item and will be used for requisitioning purposes.

c. Description, Column 3. This column indicates the Federal item name and any additional description of the item require cl. A part number or other reference number is followed by the applicable five-digit Federal supply codes for manufacturer in parentheses. Each item is indented with a dot(s), i.e., An item indented "A" in the description column will be preceded with one dot; an item indented "B" will be preceded by two dots, etc.

d. Unit of Measure (U/M), Column 4. A 2 character alphabetic abbreviation indicating the amount or quantity of the item upon which the allowances are based, e.g., ft, ea, pr, etc.

e. Quantity Incorporated in Unit, Column 3. This column indicates the quantity used per reference designation (Column 10b). A "V" appearing in this column in lieu of a quantity indicates that a definite quantity cannot be indicated (e.g., SHIMS, SPACERS, etc.).

f. 30-Day DS/GS Maintenance Allowances, Columns 6 and 7.

NOTE: Allowances in GS column are for GS maintenance only.

(1) Separate columns for Direct Support (DS) and General Support (GS) indicate the total range of repair parts authorized for use at the appropriate categories.

(2) The allowance columns are divided into three sub-columns. An asterisk in these columns opposite

the first appearance of each item indicates the item is authorized on an "as required" basis. Repair parts stockage at the DS/GS levels will be based on demand and determined in accordance with AR711-16. Subsequent appearances of the same item will have the letters "REF" in the allowance columns.

g. 1-Year Allowances Per 100 Equipments/Contingency Planning Purposes, Column 8. This column indicates items required to support 100 equipments for one year. An asterisk opposite the first appearance of each item indicates the range of items required.

h. Depot Maintenance Allowances Per 100 Equipments, Column 9. This column indicates items authorized for depot maintenance of 100 equipments. An asterisk opposite the first appearance of each item indicates the range of items authorized on an "as required" basis. Subsequent appearance of the same item will have the letters "REF" in this column when shown as a supply item.

i. Illustration, Column 10. This column is divided as follows:

(1) Figure Number, Column 10a. Indicates the figure number of the illustration in which the item is shown.

(2) Item Number, Column 10b. Indicates the call-out number or reference designation used to reference the item in the illustration.

4. Special Information.

a. Identification of the USABLE ON CODES in Column 3 of this publication are:

<u>CODE</u>	<u>USED ON</u>
A	AN/ARM-92
B	AN/ARM-92A

The absence of a usable on code indicates the part is used on all models.

b. Repair parts mortality is computed from failure rates derived from experience factors with the individual parts in a variety of equipments. Variations in the specific application and periods of use of electronics equipment, the fragility of electronic piece parts, plus intangible material and quality factors intrinsic to the manufacture of electronic parts, do not permit mortality to be based on hours of end item use. However, long periods of continuous use under adverse conditions are likely to increase repair parts mortality.

c. Parts which require manufacture or assembly at a category higher than that authorized for installation will indicate in the source column the higher category.

5. How to Locate Repair Parts.

a. When Federal stock number or reference number is unknown:

(1) First. Using the table of contents, determine the functional group within which the repair part belongs. This is necessary since illustrations are prepared for functional groups and listings are divided into the same groups.

(2) Second. Find the illustration covering the functional group to which the repair part belongs.

(3) Third. Identify the repair part on the illustration and note the illustration figure and reference designation of the repair part.

(4) Fourth. Using the repair parts listing, find the functional group to which the repair part belongs and locate the illustration figure and reference designation noted on the illustration.

b. When Federal stock number or reference is known:

(1) First. Using the Index of Federal Stock Numbers and Reference Numbers, find the pertinent Federal stock number or reference number. This index is in ascending FSN sequence followed by a list of reference numbers in alpha-numeric sequence, cross-referenced to the illustration figure number and reference designation number.

(2) Second. Using the repair part listing, find the functional group of the repair part and the illustration figure number and reference designation referenced in the Index of Federal Stock Numbers and Reference Numbers.

c. When the reference designation is known:

(1) First. Locate the reference designation in the Index-Reference Designation Cross-Reference to Page Numbers.

(2) Second. Note the page number; then locate the item in the list by the page numbers.

6. Federal Supply Code.

This paragraph lists the Federal supply and the associated manufacturer's name.

code **Manufacturer**

01121 Allen-Bradley Co.
 1201 S. 2nd St.
 Milwaukee, WI 53204

01686 RCL Electronics Inc.
 195 M Gregor St.
 Manchester, NH 03102

02660 Bu&erramo Corp, The
 Amphenol Connector Div.
 2801 S. 25th Ave.
 Broadview, IL 60153

02987 Bendix Corp.
 The Flight & Engine Instruments Division
 South Montrose, PA 18843

06481 Litton Systems Inc.
 Guidance and Control Systems Div.
 5500 Canoga Ave.
 Woodland Hills, CA 91364

Code	Manufacturer
07688	Joint Electron Device Engineering Council Washington, D.C. 20013
08664	Bristol Co., Div of American Chain and Cable Co., Inc. 40 Bristol St. Waterbury, CT 06720
08717	Sloan Co., The PO Box 367 7704 San Fernando Rd. Sun Valley, CA 91352
09922	Burndy Corp. Richards Ave. Norwalk, CT 06852
13499	Collins Radio Company 5225 C Ave. N.E. Cedar Rapids, IA 52406
24363	Executive Instruments Inc. P.O. Box 75 Addison, TX 75001
27545	Hartford-Universal Co. 1022 Elm St. Rocky Hill, CT 06067
55026	Simpson Electric Co. Division of American Gage and Machine Co. 5200 W. Kinzie St. Chicago, IL 60644
58474	Superior Electric Co., The 383 Middle St. Bristol, CT 06010
70674	ADC Products Div. of Magnetic Controls Co. 4900 West 78th St. Minneapolis, MN 55426
71286	Camloc Division Rex Chainbelt, Inc. 22 Spring Valley Road Paramus, N.J. 07652
71400	Bussman Mfg. Division of McGraw and Edison Co. 2536 W. University St. St. Louis, MO 63017
72619	Dialight Corp. 60 Steward Ave. Brooklyn, NY 11237
72794	Dzus Fastener Co. Inc. 425 Union Blvd. West Islip, NY 11795

Code	Manufacturer	Code	Manufacturer
72962	Elastic Stop Nut Division of Amerace Es na Corp. 2330 Vauxhall Road Union, NJ 07083	82104	Standard Grigsby Co. 920 Rathbone Ave. Aurora, IL 60507
73386	Freed Transformer Co., Inc. 1736 Weirfield St. Brooklyn, NY 11227	88245	Litton Precision Products Inc. USECO Div Litton Industries 13536 Saticoy Street Van Nuys, CA 91409
74284	Skydyne Inc. River View Port Jervis, NY 12771	90030	USM Corp USM Machinery Div 181 Elliot St Beverly, MA 01915
75543	La velle Rubber Co. 424 N. Wood Chicago, IL 60622	90484	ITT, Surprenant Div. Clinton, MA 01510
76854	Oak Mfg. Co. Div. of Oak Electro/Netics Corp. S. Main Crystal Lake, IL 60014	91663	Armel Electronics Inc 1601 75th St North Bergen, NJ 07047
77147	Patton Mac Guyer Co Div. of Avid Corp. 17 Virginia Ave. Providence, RI 02905	94130	Camden Wire Co., Inc. 12 Masonic Ave. Camden, NY 13316
77250	Pheoll Mfg. Co. Div. of Allied Products Corp. 5700 W. Roosevelt Rd. Chicago, IL 60650	95987	Weckesser Co., Inc. 4444 West Irving Park Rd. Chicago, IL 60641
77820	Bendix Corp. Electrical Components Div., The Sherman Ave. Signey, NY 13838	96906	Military Standards Promulgated by Standardization Div. Directorate of Logistic Services DSA
78189	Illinois Tool Works, Inc. Shakeproof Division St. Charges Rd. Elgin, IL 60120	97315	Ballastran Corp. Executive Blvd Interstate Industrial Park Fort Wayne, IN 46808
79807	Wrought Washer Mfg. Co. 2100 S. O Bay St. Milwaukee, WI 53207	98003	Nielson Hardware Corp 770 Weathersfield Ave Hartford, CT 06114
80058	Joint Electronics Type Designation System	98291	Sealectro Corp 225 Hoyt Mamaroneck, NY 10544
80089	Essex International, Inc. Control Div. 131 Godfrey St. Logansport, IN 46947	98376	Zero Mfg Co. West Division 1121 Chestnut St Burbank, CA 91503
81073	Grayhill, Inc. 561 Hillgrove Ave. La Grange, IL 60525	7. Recommendations for Maintenance Publication Improvements. Report of errors, omissions, and recommendations for improving this publication by the individual user is encouraged. Reports should be submitted on DA Form 2028 (Recommended Changes to DA Publication) and forwarded direct to Commander, U.S. Army Electronics Command, ATTN: AMSEL-MA-AN, Fort Monmouth, New Jersey 07703.	
81349	Military Specifications Promulgated by Standardization Div. Directorate of Logistic Services DSA		
81350	Joint Army-Navy Specifications Promulgated by Standardization Div. Directorate of Logistic Services DSA		

SECTION II REPAIR PARTS FOR DIRECT SUPPORT, GENERAL SUPPORT, AND DEPOT MAINTENANCE

SMR CODE	FEDERAL STOCK NUMBER	DESCRIPTION REFERENCE NUMBER & MFR CODE	USABLE ON CODE	(4) UNIT OF MEAS	(5) QTY INC IN UNIT	(6) 30-DAY DS MAINT ALLOWANCE			(7) 30-DAY GS MAINT ALLOWANCE			(8) 1 YR ALW PER EQUIP COM-TCKY	(9) DEPOT MAINT ALW PER 100 EQUIP	(10) ILLUSTRATIONS	
						(A)	(B)	(C)	(A)	(B)	(C)	FIG NO	(A) ITEM NO OR REFERENCE DESIGNATION		
						1-20	21-50	51-100	1-20	21-50	51-100				
A001A	6625-999-5118	TEST SETS, RADIO AN/ARM-92 AND AN/ARM-92A .TEST SET, RADIO-476U-3 AN/ARM-92(80058)	A	EA	1									1	1
A001	6625-159-2399	.TEST SET, RADIO-476U-3 AN/ARM-92A(80058)	B	EA	1									2	1
A--H-R A002		.CASE ASSEMBLY, BOTTOM: 762-1555-002(13499)		EA	1									3	MP1
M--H-- A003		.BRACKET, DIVIDER: 762-1564-002(13499)		EA	1									3	MP1MP1
P--H-- A004	5310-857-5547	.NUT, SELF-LOCKING, HEXAGON: 68NM62(72962)		EA	4				*	*	*	*	*	3	MP1MP1H1
P--H-- A005	5305-054-6653	SCREW, MACHINE MS51957-29(96906)		EA	4				*	*	*	*	*	3	MP1MP1H2
P--H-- A006	5310-531-9514	.WASHER, FLAT: 310-6360-000(79807)		EA	4				*	*	*	*	*	3	MP1MP1H3
M--H-- A007		.BRACKET, PANEL MOUNTIN: 762-1553-003(13499)		EA	1									3	MP1MP2
P--H-- A008	5310-857-5547	.NUT, SELF-LOCKING, HEXAGON: SAME AS A004		EA	4				REF	REF	REF	REF	REF	3	MP1MP2H1
P--H-- A009	5305-054-6653	.SCREW, MACHINE: SAME AS A005		EA	4				REF	REF	REF	REF	REF	3	MP1MP2H2
A--H-R A010		.CASE, BOTTOM: 021-0361-030(74284)		EA	1									3	MP1MP3
M--H-- A011		.COVER, STOWAGE: 762-1565-002(13499)		EA	1									3	MP1MP4
P--H-- A012	5310-857-5547	.NUT, SELF-LOCKING, HEXAGON: SAME AS A004		EA	3				REF	REF	REF	REF	REF	3	MP1MP4H1
P--H-- A013	5305-054-6653	.SCREW, MACHINE: SAME AS A005		EA	3				REF	REF	REF	REF	REF	3	MP1MP4H2
P--H-- A014	5325-171-4365	.RECEPTACLE, FASTENER: 212-12N(71286)		EA	1				*	*	*	*	*	3	MP1MP5
P--H-- A015	5320-584-0672	.RIVET, SOLID: MS20426AD3-6(96906)		EA	2				*	*	*	*	*	3	MP1MP5H1
A--H-S A023A	6625-926-4420	.TEST SET, RADIO: TS2500ARM92(80058)	A	EA	1									1	A1
A--H-S A023	6625-159-2400	.TEST SET, RADIO: TS2500AARM92(80058)	B	EA	1									2	A1
P--H-- A024	5305-054-6651	.SCREW, MACHINE: MS51957-27(96906)		EA	7				*	*	*	*	*	2	A1H1
P--H-- A025	5310-275-1347	.WASHER, FLAT: 310-0046-000(79807)		EA	7				*	*	*	*	*	2	A1H2
P--H-- A026	6625-842-9720	.AMMETER: 7213(55026)		EA	1				*	*	*	*	*	2	A1M1
P--H-- A027	6625-966-1933	.AMMETER: 8185(55026)		EA	1				*	*	*	*	*	2	A1M2
P--H-- A028	6625-966-1932	.AMMETER: 8186(55026)		EA	1				*	*	*	*	*	2	A1M3
A--H-R A029A		.BRACKET ASSEMBLY: 762-1707-001(13499)	A	EA	1									4	A1A1
A--H-R A029		.BRACKET ASSEMBLY: 762-1707-010(13499)	B	EA	1									4	A1A1
P--H-- A030	5310-616-8660	.NUT, PLAIN, HEXAGON: P313-0045-00(77250)		EA	1				*	*	*	*	*	4	A1A1H1

SECTION II (1)	DEPOT MAINTENANCE (2)	(CONTINUED) (3)	(4)	(5)	(6)			(7)			(8)	(9)	(10)									
					SMR CODE	FEDERAL STOCK NUMBER	DESCRIPTION REFERENCE NUMBER & MFR CODE	USABLE ON CODE	UNIT OF MEAS	QTY INC IN UNIT			30-DAY DS MAINT ALLOWANCE			30-DAY GS MAINT ALLOWANCE			1 YR ALW PER EQUIP COM- TGCY	DEPOT MAINT ALW PER 100 EQUIP	ILLUSTRATIONS (A) FIG NO	(B) ITEM NO OR REFERENCE DESIGNATION
													(A) 1-20	(B) 21-50	(C) 51-100	(A) 1-20	(B) 21-50	(C) 51-100				
P--H-- A031	5310-208-3786	...NUT, FLAIN, HEXAGON: F313-0132-000(77250)		EA	3				*	*	*	*	*		4	A1A1H2						
P--H-- A032	5305-763-7822	...SCREW, MACHINE: MS51959-14(96906)		EA	3				*	*	*	*	*		4	A1A1H3						
P--H-- A033	5305-763-6963	...SCREW, MACHINE: MS51959-28(96906)		EA	1				*	*	*	*	*		4	A1A1H4						
P--H-- A034	5310-616-3555	...WASHER, LOCK: MS35333-71(96906)		EA	1				*	*	*	*	*		4	A1A1H5						
P--H-- A035	5310-550-3713	...WASHER, LOCK: MS35333-70(96906)		EA	3				*	*	*	*	*		4	A1A1H6						
M--H-- A036		...BRACKET, COMPONENT MOUNTING: 772-1661-001(13499)		EA	1										5	A1A1MP1						
P--H-- A037	5340-803-4705	...CLAMP, LOOP HP5N(09922)		EA	1				*	*	*	*	*		5	A1A1MP2						
P--H-- A038	5310-616-8660	...NUT, FLAIN, HEXAGON: SAME AS A030		EA	1				REF	REF	REF	REF	REF		5	A1A1MP2H1						
P--H-- A039	5305-054-6654	...SCREW, MACHINE: MS51957-30(96906)		EA	1				*	*	*	*	*		5	A1A1MP2H2						
P--H-- A040	5310-616-3555	...WASHER, LOCK: SAME AS A034		EA	1				REF	REF	REF	REF	REF		5	A1A1MP2H3						
P--H-- A041	5340-200-2691	...CLAMP, LOOP: HP6N(09922)	B	EA	1				*	*	*	*	*		4	A1A1MP3						
P--H-- A042	5310-857-5547	...NUT, SELF-LOCKING, HEXAGON: SAME AS A004		EA	1				REF	REF	REF	REF	REF		4	A1A1MP3H1						
P--H-- A043	5305-054-6654	...SCREW, MACHINE: SAME AS A039		EA	1				REF	REF	REF	REF	REF		4	A1A1MP3H2						
P--H-- A044	5340-598-0296	...CLAMP, LOOP: NP7N(09922)		EA	1				*	*	*	*	*		5	A1A1MP4						
P--H-- A045	5310-857-5547	...NUT, SELF-LOCKING, HEXAGON: SAME AS A004		EA	1				REF	REF	REF	REF	REF		5	A1A1MP4H1						
P--H-- A046	5305-054-6654	...SCREW, MACHINE SAME AS A039		EA	1				REF	REF	REF	REF	REF		5	A1A1MP4H2						
P--H-- A047	5340-336-8164	...CLAMP, LOOP: HP10N(09922)		EA	1				*	*	*	*	*		5	A1A1MP5						
P--H-- A048	5310-857-5547	...NUT, SELF-LOCKING, HEXAGON: SAME AS A004		EA	1				REF	REF	REF	REF	REF		5	A1A1MP5H1						
P--H-- A049	5305-054-6654	...SCREW, MACHINE: SAME AS A039		EA	1				REF	REF	REF	REF	REF		5	A1A1MP5H2						
P--H-- A050	5935-149-3427	...CONNECTOR, RECEPTACLE: MS3102A145P (96906)		EA	1				*	*	*	*	*		5	A1A1J5						
P--H-- A051	5310-208-3786	...NUT, FLAIN, HEXAGON: SAME AS A031		EA	4				REF	REF	REF	REF	REF		5	A1A1J5H1						
P--H-- A052	5305-054-6649	...SCREW, MACHINE: MS51957-15(96906)		EA	4				*	*	*	*	*		5	A1A1J5H2						
P--H-- A053	5310-550-3713	...WASHER, LOCK: SAME AS A035		EA	4				REF	REF	REF	REF	REF		5	A1A1J5H3						
M--H-- A054		...GROMMET-MODIFIED: 762-1715-000(13499)		EA	1										5	A1A1MP6						
P--H-- A055	5945-500-7924	...RELAY, ARMATURE: 22700-20(80089)		EA	1				*	*	*	*	*		5	A1A1K1						

SECTION II DEPOT MAINTENANCE (CONTINUED)				(4)	(5)	(6)			(7)			(8)	(9)	(10)	
(1)	(2)	(3)				30-DAY DS MAINT ALLOWANCE			30-DAY GS MAINT ALLOWANCE			1 YR ALW PER EQUIP COM-TGCY	DEPOT MAINT ALW PER 100 EQUIP	ILLUSTRATIONS	
SMR CODE	FEDERAL STOCK NUMBER	DESCRIPTION	USABLE ON CODE	UNIT OF MEAS	QTY INC IN UNIT	(A)	(B)	(C)	(A)	(B)	(C)			(A)	(B)
		REFERENCE NUMBER & MFR CODE				1-20	21-50	51-100	1-20	21-50	51-100			FIG NO	ITEM NO OR REFERENCE DESIGNATION
P--H-- A056	5310-208-3786	...NUT,PLAIN,HEXAGON: SAME AS A031		EA	3				REF	REF	REF	REF	REF	5	A1A1K1H1
P--H-- A057	5310-550-3713	...WASHER,LOCK: SAME AS A035		EA	3				REF	REF	REF	REF	REF	5	A1A1K1H2
P--H-- A058	5945-685-2905	...RELAY,ARMATURE: 22700-19(80089)		EA	1				*	*	*	*	*	5	A1A1K2
P--H-- A059	5310-208-3786	...NUT,PLAIN,HEXAGON: SAME AS A031		EA	3				REF	REF	REF	REF	REF	5	A1A1K2H1
P--H-- A060	5310-550-3713	...WASHER,LOCK: SAME AS A035		EA	3				REF	REF	REF	REF	REF	5	A1A1K2H2
P--H-- A061	5905-816-8554	...RESISTOR,FIXED,COMPOSITION: RCR07G103K(81349)		EA	1				*	*	*	*	*	5	A1A1R4
P--H-- A062	5905-988-2313	...RESISTOR,FIXED,FILM: RM60D1211F(81349)		EA	1				*	*	*	*	*	5	A1A1R2
P--H-- A063	5905-069-0897	...RESISTOR,FIXED,FILM: RM60D3740F(81349)		EA	1				*	*	*	*	*	5	A1A1R3
P--H-- A064	5905-905-9356	...RESISTOR,FIXED,FILM: RL32S271G(81349)		EA	1				*	*	*	*	*	5	A1A1R5
P--H-- A065	5905-730-1489	...RESISTOR,FIXED,FILM: RL07S472J(81349)		EA	1				*	*	*	*	*	5	A1A1R6
P--H-- A066	5905-730-1489	...RESISTER,FIXED,FILM: SAME AS A065		EA	1				REF	REF	REF	REF	REF	5	A1A1R7
P--H-- A067	5905-681-1197	...RESISTOR,VARIABLE: RA20LASB102A(81349)		EA	1				*	*	*	*	*	5	A1A1R1
P--H-- A068	5310-208-4662	...NUT,PLAIN,HEXAGON: P313-0062-000(77250)		EA	1				*	*	*	*	*	5	A1A1R1H1
P--H-- A069	5310-883-5931	...WASHER,LOCK: 1720-02(78189)		EA	1				*	*	*	*	*	5	A1A1R1H2
P--H-- A070A	5961-892-0889	...SEMICONDUCTOR DEVICE,DIODE: JAN1N938(81349)	A	EA	1				*	*	*	*	*	5	A1A1CR1
P--H-- A070	5961-853-2607	...SEMICONDUCTOR DEVICE,DIODE: JAN1N198M(81350)	B	EA	1				*	*	*	*	*	5	A1A1CR1
P--H-- A071	5961-087-6047	...SEMICONDUCTOR DEVICE,DIODE: 1N645(07688)		EA	1				*	*	*	*	*	5	A1A1CR2
M--H-- A072		...TERMINAL BOARD: 762-1677-002(13499)		EA	1									5	A1A1TB1
P--H-- A073	5310-053-1551	...POST,ELECTRICAL-MECHAN- ICAL EQUIPMENT: 540-9041-003(13499)		EA	2				*	*	*	*	*	5	A1A1TB1H1
P--H-- A074	5305-054-5647	...SCREW MACHINE MS51957-13(96906)		EA	4				*	*	*	*	*	5	A1A1TB1H2
P--H-- A075	5310-550-3713	...WASHER,LOCK: SAME AS A035		EA	2				REF	REF	REF	REF	REF	5	A1A1TB1H3
P--H-- A076	5940-549-9610	...TERMINAL BOARD: 1181(06481)		EA	1				*	*	*	*	*	5	A1A1TB2
P--H-- A077	5305-680-6757	...SCREW MACHINE: P343-0386-000(77250)		EA	2				*	*	*	*	*	5	A1A1TB2H1
P--H-- A078	5310-940-3455	...WASHER,LOCK: 1203-00(78189)		EA	2				*	*	*	*	*	5	A1A1TB2H2
P--H-- A079	5940-847-3138	...TERMINAL,LUG: 2104-04-01-2520N(78189)		EA	1				*	*	*	*	*	5	A1A1E1
P--H-- A080	5940-847-3138	...TERMINAL,LUG: SAME AS A079		EA	1				REF	REF	REF	REF	REF	5	A1A1E2
P--H-- A081	5940-847-3138	...TERMINAL,LUG: SAME AS A079		EA	1				REF	REF	REF	REF	REF	5	A1A1E3

SECTION II DEPOT MAINTENANCE (CONTINUED)															
(1)	(2)	(3)	(4)	(5)	(6)			(7)			(8)	(9)	(10)		
SMR CODE	FEDERAL STOCK NUMBER	DESCRIPTION	USABLE ON CODE	UNIT OF MEAS	QTY INC IN UNIT	30-DAY DS MAINT ALLOWANCE			30-DAY GS MAINT ALLOWANCE			1 YR ALW PER EQUIP COM-TGCY	DEPOT MAINT ALW PER 100 EQUIP	ILLUSTRATIONS (A) FIG NO	(B) ITEM NO OR REFERENCE DESIGNATION
		REFERENCE NUMBER & MFR CODE				(A)	(B)	(C)	(A)	(B)	(C)				
P--H-- A082	5940-847-3138	... TERMINAL, LUG: SAME AS A079		EA	1				REF	REF	REF	REF	REF	5	A1A1E4
P--H-- A083	5940-061-0050	... TERMINAL, STUD: RTMT16M(91653)		EA	1				*	*	*	*	*	5	A1A1E5
P--H-- A084	5305-054-5647	... SCREW, MACHINE: SAME AS A074		EA	1				REF	REF	REF	REF	REF	5	A1A1E5H1
P--H-- A085	5310-550-3713	... WASHER, LOCK: SAME AS A035		EA	1				REF	REF	REF	REF	REF	5	A1A1E5H2
P--H-- A086	5950-903-4357	... TRANSFORMER, POWER, FIXED AUTOTRANSFORMER: BC3258(97315)		EA	1				*	*	*	*	*	5	A1A1T1
P--H-- A087	5310-208-3786	... NUT, PLAIN, HEXAGON: SAME AS A031		EA	4				REF	REF	REF	REF	REF	5	A1A1T1H1
P--H-- A088	5310-550-3713	... WASHER, LOCK: SAME AS A035		EA	4				REF	REF	REF	REF	REF	5	A1A1T1H2
P--H-- A089	5950-738-9448	... TRANSFORMER, SPECIAL PRECISION: 36747(73386)		EA	4				REF	REF	REF	REF	REF	5	A1A1T1H2
P--H-- A090	5310-616-8660	... NUT, PLAIN, HEXAGON: SAME AS A030		EA	4				REF	REF	REF	REF	REF	5	A1A1T2H1
P--H-- A091	5310-616-3555	... WASHER, LOCK: SAME AS A034		EA	4				REF	REF	REF	REF	REF	5	A1A1T2H2
M--H-- A092		... CABLE ASSEMBLY: 762-1664-001(13499)		EA	1									3	A1W2
P--H-- A093	5935-866-2255	... CONNECTOR, PLUG, ELECTRICAL: PT06A20-41SSR(77820)		EA	1				*	*	*	*	*	3	A1W2P2
P--H-- A094	5935-729-8688	... CONNECTOR, PLUG ELECTRICAL: PT06A12-10SSR(77820)		EA	1				*	*	*	*	*	3	A1W2P3
M--H-- A095		... CABLE ASSEMBLY, CONTROL: 762-1708-001(13499)		EA	1									6	A1W3
P--H-- A096	5935-866-2255	... CONNECTOR, PLUG ELECTRICAL: SAME AS A093		EA	1				REF	REF	REF	REF	REF	6	A1W3P5
M--H-- A097		... CABLE ASSEMBLY: 762-1708-002(13499)		EA	1									6	A1W4
P--H-- A098	5935-866-2254	... CONNECTOR, PLUG, ELECTRICAL: PT06A14-19SSR(77820)		EA	1				*	*	*	*	*	6	A1W4P6
P--H-- A099	6625-944-9758	... CABLE ASSEMBLY, POWER: 762-1493-001(13499)		EA	1				*	*	*	*	*	6	A1W1
P--H-- A100	5935-666-4860	... CLAMP, CABLE, ELECTRI- CAL CONNECTOR: 97-3057-6(02660)		EA	1				*	*	*	*	*	6	A1W1MP1
P--H-- A101	5935-196-2234	... CONNECTOR, PLUG, ELECTRICAL: MS3106A14855(96906)		EA	1				*	*	*	*	*	6	A1W1P1
P--H-- A102	5935-686-9523	... CAP, PROTECTIVE SEAL: 10-101960-143(77820)		EA	1				*	*	*	*	*	2	A1MP9
P--H-- A103	5935-196-2234	... CONNECTOR, PLUG, ELECTRICAL: SAME AS A101		EA	1				REF	REF	REF	REF	REF	6	A1P1
P--H-- A104	5935-280-2195	... ADAPTER, CABLE TO CONNECTOR: MS3057-6A(96906)		EA	1				*	*	*	*	*	6	A1P1MP1

SECTION II DEPOT MAINTENANCE (CONTINUED)															
(1)	(2)	(3)	(4)	(5)	(6)			(7)			(8)	(9)	(10)		
SMR CODE	FEDERAL STOCK NUMBER	DESCRIPTION	USABLE ON CODE	UNIT OF MEAS	QTY INC IN UNIT	30-DAY DS MAINT ALLOWANCE			30-DAY GS MAINT ALLOWANCE			1 YR ALW PER EQUIP COM-TGCY	DEPOT MAINT ALW PER 100 EQUIP	ILLUSTRATIONS (A) FIG NO	(B) ITEM NO OR REFERENCE DESIGNATION
P--H-- A082	5940-847-3138	... TERMINAL, LUG: SAME AS A079		EA	1				REF	REF	REF	REF	REF	5	A1A1E4
P--H-- A083	5940-061-0050	... TERMINAL, STUD: RTMT16M(91653)		EA	1				*	*	*	*	*	5	A1A1E5
P--H-- A084	5305-054-5647	... SCREW, MACHINE: SAME AS A074		EA	1				REF	REF	REF	REF	REF	5	A1A1E5H1
P--H-- A085	5310-550-3713	... WASHER, LOCK: SAME AS A035		EA	1				REF	REF	REF	REF	REF	5	A1A1E5H2
P--H-- A086	5950-903-4357	... TRANSFORMER, POWER, FIXED AUTOTRANSFORMER: BC3258(97315)		EA	1				*	*	*	*	*	5	A1A1T1
P--H-- A087	5310-208-3786	... NUT, PLAIN, HEXAGON: SAME AS A031		EA	4				REF	REF	REF	REF	REF	5	A1A1T1H1
P--H-- A088	5310-550-3713	... WASHER, LOCK: SAME AS A035		EA	4				REF	REF	REF	REF	REF	5	A1A1T1H2
P--H-- A089	5950-738-9448	... TRANSFORMER, SPECIAL PRECISION: 36747(73386)		EA	4				REF	REF	REF	REF	REF	5	A1A1T1H2
P--H-- A090	5310-616-8660	... NUT, PLAIN, HEXAGON: SAME AS A030		EA	4				REF	REF	REF	REF	REF	5	A1A1T2H1
P--H-- A091	5310-616-3555	... WASHER, LOCK: SAME AS A034		EA	4				REF	REF	REF	REF	REF	5	A1A1T2H2
M--H-- A092		... CABLE ASSEMBLY: 762-1664-001(13499)		EA	1									3	A1W2
P--H-- A093	5935-866-2255	... CONNECTOR, PLUG, ELECTRICAL: PT06A20-41SSR(77820)		EA	1				*	*	*	*	*	3	A1W2P2
P--H-- A094	5935-729-8688	... CONNECTOR, PLUG ELECTRICAL: PT06A12-10SSR(77820)		EA	1				*	*	*	*	*	3	A1W2P3
M--H-- A095		... CABLE ASSEMBLY, CONTROL: 762-1708-001(13499)		EA	1									6	A1W3
P--H-- A096	5935-866-2255	... CONNECTOR, PLUG ELECTRICAL: SAME AS A093		EA	1				REF	REF	REF	REF	REF	6	A1W3P5
M--H-- A097		... CABLE ASSEMBLY: 762-1708-002(13499)		EA	1									6	A1W4
P--H-- A098	5935-866-2254	... CONNECTOR, PLUG, ELECTRICAL: PT06A14-19SSR(77820)		EA	1				*	*	*	*	*	6	A1W4P6
P--H-- A099	6625-944-9758	... CABLE ASSEMBLY, POWER: 762-1493-001(13499)		EA	1				*	*	*	*	*	6	A1W1
P--H-- A100	5935-666-4860	... CLAMP, CABLE, ELECTRI- CAL CONNECTOR: 97-3057-6(02660)		EA	1				*	*	*	*	*	6	A1W1MP1
P--H-- A101	5935-196-2234	... CONNECTOR, PLUG, ELECTRICAL: MS3106A14855(96906)		EA	1				*	*	*	*	*	6	A1W1P1
P--H-- A102	5935-686-9523	... CAP, PROTECTIVE SEAL: 10-101960-143(77820)		EA	1				*	*	*	*	*	2	A1MP9
P--H-- A103	5935-196-2234	... CONNECTOR, PLUG, ELECTRICAL: SAME AS A101		EA	1				REF	REF	REF	REF	REF	6	A1P1
P--H-- A104	5935-280-2195	... ADAPTER, CABLE TO CONNECTOR: MS3057-6A(96906)		EA	1				*	*	*	*	*	6	A1P1MP1

SECTION II DEPOT MAINTENANCE (CONTINUED)										
(1)	(2)	(3)	(4)	(5)	(6)	(7)	(8)	(9)	(10)	
SMR CODE	FEDERAL STOCK NUMBER	DESCRIPTION	USABLE ON CODE	UNIT OF MEAS	QTY INC IN UNIT	30-DAY DS MAINT ALLOWANCE (A) (B) (C)	30-DAY GS MAINT ALLOWANCE (A) (B) (C)	1 YR ALW PER EQUIP COM-TGCY	DEPOT MAINT ALW PER 100 EQUIP	ILLUSTRATIONS (A) FIG NO (B) ITEM NO OR REFERENCE DESIGNATION
P--H-- A105	5935-552-2374	...CONNECTOR, PLUG ELECTRICAL: MS3106A22(96906)		EA	1		* * *	*	*	6 A1P4
P--H-- A106	5935-223-0572	ADAPTER, CABLE TO ...CONNECTOR: MS3057-12A(96906)		EA	1		* * *	*	*	6 A1P4MP1
P--H-- A107	5935-827-1336	...CONNECTOR, RECEPTACLE, ELECTRICAL: PT02A14-19P(77820)		EA	1		* * *	*	*	7 A1J4
P--H-- A108	5310-208-3786	...NUT, FLAIN, HEXAGON: SAME AS A031		EA	4		REF REF REF	REF	REF	7 A1J4H1
P--H-- A109	5305-054-5648	...SCREW, MACHINE: MS51957-14(96906)		EA	3		* * *	*	*	7 A1J4H2
P--H-- A110	5305-054-5649	...SCREW, MACHINE: SAME AS A052		EA	1		REF REF REF	REF	REF	7 A1J4H3
P--H-- A111	5310-550-3713	...WASHER, LOCK: SAME AS A035		EA	4		REF REF REF	REF	REF	7 A1J4H4
P--O-- A112	5920-474-6125	...FUSE, CARTRIDGE: F02A250V2AS(81349)		EA	1	* * *	* * *	*	*	2 A1P1
P--O-- A113	5920-280-8342	...FUSE, CARTRIDGE: F02A250V1AS(81349)		EA	1	* * *	* * *	*	*	2 A1P2
P--O-- A114	5920-280-8342	...FUSE, CARTRIDGE: SAME AS A113		EA	1	REF REF REF	REF REF REF	REF	REF	2 A1P3
P--O-- A115	5920-474-6125	...FUSE, CARTRIDGE: SAME AS A112		EA	1	REF REF REF	REF REF REF	REF	REF	2 A1P4
P--O-- A116	5920-280-8342	...FUSE, CARTRIDGE: SAME AS A113		EA	1	REF REF REF	REF REF REF	REF	REF	2 A1P5
P--O-- A117	5920-280-8342	...FUSE, CARTRIDGE: SAME AS A113		EA	1	REF REF REF	REF REF REF	REF	REF	2 A1P6
P--H-- A118	5920-892-9311	...FUSE HOLDER: HKPH(71400)		EA	1		* * *	*	*	7 A1XF1
P--H-- A119	5920-892-9311	...FUSE HOLDER: SAME AS A118		EA	1		REF REF REF	REF	REF	7 A1XF2
P--H-- A120	5920-892-9311	...FUSE HOLER: SAME AS A118		EA	1		REF REF REF	REF	REF	7 A1XF3
P--H-- A121	5920-892-9311	...FUSE HOLDER: SAME AS A118		EA	1		REF REF REF	REF	REF	7 A1XF4
P--H-- A122	5920-892-9311	...FUSE HOLDER SAME AS A118		EA	1		REF REF REF	REF	REF	7 A1XF5
P--H-- A123	5920-892-9311	...FUSE HOLDER: SAME AS A118		EA	1		REF REF REF	REF	REF	7 A1XF6
G--H-T A124	5826-505-3094	...INDICATOR, COURSE ID250AARN(80058)		EA	1					7 A1A3
P--H-- A125	5305-059-8255	...SCREW, MACHINE: MS35214-30(96906)		EA	4		* * *	*	*	2 A1A3H1
G--H-T A126A	5826-985-9171	...INDICATOR, COURSE: ID1347ARN82(80058)	A	EA	1					2 A1A4
G--H-T A126	5826-168-8397	...INDICATOR, COURSE: ID1347AARN2(80058)	B	EA	1					2 A1A4
P--H-- A127	5305-206-1288	...SCREW, MACHINE: MS35214-27(96906)		EA	4		* * *	*	*	2 A1A4H1
P--H-- A128	5935-415-6070	...JACK, TELEPHONE: 4-03649-0210(70674)		EA	1		* * *	*	*	7 A1J3

SECTION II DEPOT MAINTENANCE (CONTINUED)										(10)					
(1)	(2)	(3)	(4)	(5)	(6)			(7)			(8)	(9)	(10)		
SMR CODE	FEDERAL STOCK NUMBER	DESCRIPTION	USABLE ON CODE	UNIT OF MEAS	QTY INC IN UNIT	30-DAY DS MAINT ALLOWANCE			30-DAY GS MAINT ALLOWANCE			1 YR ALW PER EQUIP COM-TCKY	DEPOT MAINT ALW PER 100 EQUIP	(A) FIG NO	(B) ITEM NO OR REFERENCE DESIGNATION
		REFERENCE NUMBER & MFR CODE				(A)	(B)	(C)	(A)	(B)	(C)				
P--H-- A129	5310-208-4662	...NUT, PLAIN, HEXAGON: SAME AS A068		EA	2				REF	REF	REF	REF	REF	7	ALJ3H1
P--H-- A130	5310-883-5931	...WASHER, LOCK: SAME AS A069		EA	1				REF	REF	REF	REF	REF	7	ALJ3H2
P--O-- A131	5355-680-1357	...KNOB, CONTROL, PLASTIC: MS91528-1F2B(96906)		EA	1	*	*	*	*	*	*	*	*	2	ALMP2
P--O-- A132	5355-680-1357	...KNOB, CONTROL, PLASTIC: SAME AS A131		EA	1	REF	REF	REF	REF	REF	REF	REF	REF	2	ALMP3
P--O-- A132A	5355-680-1357	...KNOB, CONTROL, PLASTIC: SAME AS A131	B	EA	1	REF	REF	REF	REF	REF	REF	REF	REF	2	ALMP1
P--O-- A133	5355-579-1210	...KNOB, CONTROL, PLASTIC: MS91528-3F2B(96906)		EA	1	*	*	*	*	*	*	*	*	2	ALMP4
P--O-- A134	6240-155-7836	...LAMP, INCANDESCENT: MS25237-327(96906)		EA	1	*	*	*	*	*	*	*	*	2	ALDS1
P--O-- A135	6240-155-7836	...LAMP, INCANDESCENT: SAME AS A134		EA	1	REF	REF	REF	REF	REF	REF	REF	REF	2	ALDS2
P--O-- A136	6240-155-7836	...LAMP, INCANDESCENT: SAME AS A134		EA	1	REF	REF	REF	REF	REF	REF	REF	REF	2	ALDS3
P--O-- A137	6210-990-4637	...LENS, LIGHT, INDICATOR: 162-0931(72619)		EA	1	*	*	*	*	*	*	*	*	2	AL1E1
P--O-- A138	6210-990-4637	...LENS, LIGHT, INDICATOR: SAME AS A137		EA	1	REF	REF	REF	REF	REF	REF	REF	REF	2	AL1E2
P--O-- A139	6210-990-4637	...LENS, LIGHT, INDICATOR: SAME AS A137		EA	1	REF	REF	REF	REF	REF	REF	REF	REF	2	AL1E3
P--H-- A140	6210-813-8265	...LIGHT, INDICATOR: 162-8430-09-502(72619)		EA	1				*	*	*	*	*	7	ALXDS1
P--H-- A141	6210-813-8265	...LIGHT, INDICATOR: SAME AS A140		EA	1				REF	REF	REF	REF	REF	7	ALXDS2
P--H-- A142	6210-813-8265	...LIGHT, INDICATOR: SAME AS A140		EA	1				REF	REF	REF	REF	REF	7	ALXDS3
M--D-- A143A		...PANEL 762-1554-002(13499)	A	EA	1									1	ALMP5
M--D-- A143		...PANEL 762-1554-010(13499)	B	EA	1									2	ALMP5
M--H-- A144A		...PLATE, IDENTIFICATION: 616-5562-000(13499)	A	EA	1									1	ALMP6
M--H-- A144		...PLATE, IDENTIFICATION: 616-5651-001(13499)	B	EA	1									2	ALMP6
P--H-- A145	5305-054-5635	...SCREW, MACHINE MS51957-1(96906)		EA	2				*	*	*	*	*	2	ALMP6H1
P--H-- A146	5940-356-2493	...POST, BINDING DF30RC(58474)		EA	1				*	*	*	*	*	7	ALJ1
P--H-- A147	5940-269-2219	...POST, BINDING: DF30BC(58474)		EA	1				*	*	*	*	*	7	ALJ2
M--H-- A148		...RECEPTACLE, STRIP: 762-1556-001(13499)		EA	1									6	ALMP7
P--H-- A149	5310-208-3786	...NUT, PLAIN, HEXAGON: SAME AS A031		EA	2				REF	REF	REF	REF	REF	6	ALMP7H1
P--H-- A150	5305-770-2579	...SCREW, MACHINE: MS51959-15(96906)		EA	2				*	*	*	*	*	6	ALMP7H2
P--H-- A151	5310-550-3713	...WASHER, LOCK: SAME AS A035		EA	2				REF	REF	REF	REF	REF	6	ALMP7H3

SECTION II DEPOT MAINTENANCE (CONTINUED)																
(1)	(2)	(3)	(4)	(5)	(6)	(7)			(8)	(9)	(10)					
SMR CODE	FEDERAL STOCK NUMBER	DESCRIPTION REFERENCE NUMBER & MFR CODE	USABLE ON CODE	UNIT OF MEAS	QTY INC IN UNIT	30-DAY DS MAINT ALLOWANCE (A) (B) (C)			30-DAY GS MAINT ALLOWANCE (A) (B) (C)			1 YR ALW PER EQUIP COM-TGCY	DEPOT MAINT ALW PER 100 EQUIP	ILLUSTRATIONS (A) FIG NO	(B) ITEM NO OR REFERENCE DESIGNATION	
X2-H-- A173	6145-160-4775	...WIRE, ELECTRICAL; TIN PLATED; 22 AWG; SOLID COPPER WIRE; 421-2220-000-(94130)		FT	V											A1W6
X2-H-- A174		...WIRE, ELECTRICAL; CLEAR OR WHITE; 26 AWG; SOLID; SILVER PLATED COPPER WIRE; WTE26A(90484)		FT	V											A1W7
X2-H-- A175	6145-548-0969	...WIRE, ELECTRICAL; WHITE; 7 STRAND; 22 AWG; SILVER PLATED COPPER; MILN1687STYPPEE22-9(81349)		FT	V											A1W8
X2-H-- A176		...WIRE, ELECTRICAL; WHITE WITH BLACK TRACER; 7 STRAND; 22 AWG; SILVER PLATED COPPER; MILN1687STYPPEE22-90(81349)		FT	V											A1W9
X2-H-- A177	6145-686-4941	...WIRE, ELECTRICAL; WHITE WITH BROWN TRACER; 7 STRAND; 22 AWG; SILVER PLATED COPPER; MILN1687STYPPEE22-91(81349)		FT	V											A1W10
X2-H-- A178		...WIRE, ELECTRICAL; WHITE WITH RED TRACER; 7 STRAND; 22 AWG; SILVER PLATED COPPER; MILN1687STYPPEE22-92(81349)		FT	V											A1W11
X2-H-- A179	6145-686-4939	...WIRE, ELECTRICAL; WHITE WITH ORANGE TRACER; 7 STRAND; 22 AWG; SILVER PLATED COPPER; MILN1687STYPPEE22-93(81349)		FT	V											A1W12
X2-H-- A180		...WIRE, ELECTRICAL; WHITE WITH GREEN TRACER; 7 STRAND; 22 AWG; SILVER PLATED COPPER; MILN1687STYPPEE22-95(81349)		FT	V											A1W13
X2-H-- A181	6145-686-4937	...WIRE, ELECTRICAL; WITE WITH BLUE TRACER; 7 STRAND; 22 AWG; SILVER PLATED COPPER; MILN1687STYPPEE22-96(81349)		FT	V											A1W14
X2-H-- A182		...WIRE, ELECTRICAL; WHITE WITH BLACK AND RED TRACER; 7 STRAND; 22 AWG; SILVER PLATED COPPER; MILN1687STYPPEE22-902(81349)		FT	V											A1W15
X2-H-- A183	6145-060-9083	...WIRE, ELECTRICAL; WHITE WITH BLACK AND ORANGE TRACER; 7 STRAND; 22 AWG; SILVER PLATED COPPER; MILN1687STYPPEE22-903(81349)		FT	V											A1W16
X2-H-- A184	6145-841-2913	...WIRE, ELECTRICAL; WHITE WITH BLACK AND GREEN TRACER; 7 STRAND; 22 AWG SILVER PLATED COPPER; MILN1687STYPPEE22-905(81349)		FT	V											A1W17
X2-H-- A185	6145-686-5274	...WIRE, ELECTRICAL; WHITE WITH BLACK AND BLUE TRACER; 7 STRAND; 22 AWG; SILVER PLATED COPPER; MILN1687STYPER-906(81349)		FT	V											A1W18
X2-H-- A186	6145-060-9078	...WIRE, ELECTRICAL; WHITE WITH BROWN AND RED TRACER; 7 STRAND; 22 AWG; SILVER PLATED COPPER; MILN1687STYPPEE22-912(81349)		FT	V											A1W19

SECTION II DEPOT MAINTENANCE (CONTINUED)			(4)	(5)	(6)	(7)	(8)	(9)	(10)						
(1)	(2)	(3)							ILLUSTRATIONS						
SMR CODE	FEDERAL STOCK NUMBER	DESCRIPTION	USABLE ON CODE	UNIT OF MEAS	QTY INC IN UNIT	30-DAY DS MAINT ALLOWANCE			30-DAY GS MAINT ALLOWANCE			1 YR ALW PER EQUIP COM-TGCY	DEPOT MAINT ALW PER 100 EQUIP	(A) FIG NO	(B) ITEM NO OR REFERENCE DESIGNATION
		REFERENCE NUMBER & MFR CODE				(A)	(B)	(C)	(A)	(B)	(C)				
X2-H-- A187	6145-686-4954	...WIRE, ELECTRICAL; WHITE WITH BROWN AND ORANGE TRACER; 7 STRAND; 22 AWG; SILVER PLATED COPPER; MILN16878TYPEE22-913(81349)		FT	V	1-20	21-50	51-100	1-20	21-50	51-100				A1W20
X2-H-- A188	6145-841-3247	...WIRE, ELECTRICAL; WHITE WITH BROWN AND GREEN TRACER; 7 STRAND; 22 AWG; SILVER PLATED COPPER; MILN16878TYPEE22-915(81349)		FT	V										A1W21
X2-H-- A189	6145-928-9896	...WIRE, ELECTRICAL; WHITE WITH BROWN AND BLUE TRACER; 7 STRAND; 22 AWG; SILVER PLATED COPPER; MILN16878TYPEE22-916(81349)		FT	V										A1W22
X2-H-- A190	6145-686-4952	...WIRE, ELECTRICAL; WHITE WITH RED AND ORANGE TRACER; 7 STRAND; 22 AWG; SILVER PLATED COPPER; MILN16878TYPEE22-923(81349)		FT	V										A1W23
X2-H-- A191	6145-952-1735	...WIRE, ELECTRICAL; WHITE WITH RED AND GREEN TRACER; 7 STRAND; 22 AWG; SILVER PLATED COPPER; MILN16787TYPEE22-925(81349)		FT	V										A1W24
X2-H-- A192		...WIRE, ELECTRICAL; WHITE WITH RED AND BLUE TRACER; 7 STRAND; 22 AWG; SILVER PLATED COPPER; MILN16878TYPEE22-926(81349)		FT	V										A1W25
X2-H-- A193	6145-686-4917	...WIRE, ELECTRICAL; WHITE WITH ORANGE AND GREEN TRACER; 7 STRAND; 22 AWG; SILVER PLATED COPPER; MILN16878TYPEE22-935(81349)		FT	V										A1W26
X2-H-- A194	6145-686-4916	...WIRE, ELECTRICAL; WHITE WITH ORANGE AND BLUE TRACER; 7 STRAND; 22 AWG; SILVER PLATED COPPER; MILN16878TYPEE22-936(81349)		FT	V										A1W27
X2-H-- A195	6145-725-3081	...WIRE, ELECTRICAL; WHITE WITH GREEN AND BLUE TRACER; 7 STRAND; 22 AWG; SILVER PLATED COPPER; MILN16787TYPEE22-956(81349)		FT	V										A1W28
X2-H-- A196	6145-965-7078	...WIRE, ELECTRICAL; WHITE WITH BLACK, RED, AND ORANGE TRACER; 7 STRAND; 22 AWG; SILVER PLATED COPPER; MILN16878TYPEE22-9023(81349)		FT	V										A1W29
X2-H-- A197	6145-965-7076	...WIRE, ELECTRICAL; WHITE WITH BLACK, RED, AND GREEN TRACER; 7 STRAND; 22 AWG; SILVER PLATED COPPER; MILN16878TYPEE22-9025(81349)		FT	V										A1W30
X2-H-- A198		...WIRE, ELECTRICAL; WHITE WITH BLACK, RED, AND BLUE TRACER; 7 STRAND; 22 AWG; SILVER PLATED COPPER; MILN16878TYPEE22-9026(81349)		FT	V										A1W31
X2-H-- A199	6145-965-7093	...WIRE, ELECTRICAL; WHITE WITH BROWN, RED, AND ORANGE TRACER; 7 STRAND; 22 AWG; SILVER PLATED COPPER; MILN16878TYPEE22-9123(81349)		FT	V										A1W32

SECTION II DEPOT MAINTENANCE (CONTINUED)																
(1)	(2)	(3)	(4)	(5)	(6)	(7)			(8)	(9)	(10)					
SMR CODE	FEDERAL STOCK NUMBER	DESCRIPTION	USABLE ON CODE	UNIT OF MEAS	QTY INC IN UNIT	30-DAY DS MAINT ALLOWANCE			30-DAY GS MAINT ALLOWANCE			1 YR ALW PER EQUIP COM-TGCY	DEPOT MAINT ALW PER 100 EQUIP	(A) FIG NO	(B) ITEM NO OR REFERENCE DESIGNATION	
		REFERENCE NUMBER & MFR CODE				(A)	(B)	(C)	(A)	(B)	(C)					
X2-H-- A200	6145-929-4205	...WIRE, ELECTRICAL; WHITE WITH BROWN, RED, AND GREEN TRACER; 7 STRAND; 22 AWG; SILVER PLATED COPPER; MILN1687STYPPEE22-9125(81349)		FT	V											A1W33
X2-H-- A201	6145-965-7073	...WIRE, ELECTRICAL; WHITE WITH BROWN, RED AND BLUE TRACER; 7 STRAND; 22 AWG; SILVER PLATED COPPER; MILN1687STYPPEE-912(81349)		FT	V											A1W34
X2-H-- A202	6145-965-7072	...WIRE, ELECTRICAL; WHITE WITH RED, ORANGE, AND GREEN TRACER; 7 STRAND; 22 AWG; SILVER PLATED COPPER; MILN1687STYPPEE22-9235(81349)		FT	V											A1W35
X2-H-- A203	6145-965-7071	...WIRE, ELECTRICAL; WHITE WITH RED, ORANGE, AND BLUE TRACER; 7 STRAND; 22 AWG; SILVER PLATED COPPER; MILN1687STYPPEE22-9236(81349)		FT	V											A1W36
X2-H-- A204	6145-965-7068	...WIRE, ELECTRICAL; WHITE WITH RED, GREEN AND BLUE TRACER; 7 STRAND; 22 AWG; SILVER PLATED COPPER; MILN1687STYPPEE22-9256(81349)		FT	V											A1W37
X2-H-- A205		...WIRE, ELECTRICAL, WHITE WITH ORANGE, GREEN, AND BLUE TRACER; 7 STRAND; 22 AWG; SILVER PLATED COPPER; MILN1687STYPPEE-9356(81349)		FT	V											A1W38
X2-H-- A206	6145-754-8057	...WIRE, ELECTRICAL; BLACK; 7 STRAND; 22 AWG; SILVER PLATED COPPER; MILN1687STYPPEE22-0(81349)		FT	V											A1W39
X2-H-- A207	6145-623-7224	...WIRE ELECTRICAL; RED; 7 STRAND; 22 AWG; SILVER PLATED COPPER; MILN1687STYPPEE22-(81349)		FT	V											A1W40
X2-H-- A208	6145-754-8058	...WIRE, ELECTRICAL; ORANGE; 7 STRAND; 22 AWG; SILVER PLATED COPPER; MILN1687STYPPEE22-3(81349)		FT	V											A1W41
X2-H-- A209	6145-623-7225	...WIRE, ELECTRICAL; GREEN; 7 STRAND; 22 AWG; SILVER PLATED COPPER; MILN1687STYPPEE22-5(81349)		FT	V											A1W42
X2-H-- A210	6145-578-6824	...WIRE, ELECTRICAL; BLUE; 7 STRAND; 22 AWG; SILVER PLATED COPPER; MILN1687STYPPEE22-6(81349)		FT	V											A1W43
X2-H-- A211	6145-581-9324	...WIRE, ELECTRICAL; BROWN; 7 STRAND; 22 AWG; SILVER PLATED COPPER; MILN1687STYPPEE22-1(81349)		FT	V											A1W44
X2-H-- A212	6145-557-3591	...WIRE, ELECTRICAL; YELLOW; 7 STRAND; 22 AWG; SILVER PLATED COPPER; MILN1687STYPPEE22-4(81349)		FT	V											A1W45
X2-H-- A213	6145-578-6978	...WIRE, ELECTRICAL, GRAY; 7 STRAND; 22 AWG; SILVER PLATED COPPER; MILN1687STYPPEE22-8(81349)		FT	V											A1W46

SECTION II DEPOT MAINTENANCE (CONTINUED)															
(1)	(2)	(3)	(4)	(5)	(6)	(7)			(8)	(9)	(10)				
SMR CODE	FEDERAL STOCK NUMBER	DESCRIPTION	USABLE ON CODE	UNIT OF MEAS	QTY INC IN UNIT	30-DAY DS MAINT ALLOWANCE			30-DAY GS MAINT ALLOWANCE			1 YR ALW PER EQUIP COM-TGCY	DEPOT MAINT ALW PER 100 EQUIP	ILLUSTRATIONS (A) FIG NO	(B) ITEM NO OR REFERENCE DESIGNATION
X2-H-- A214		...WIRE, ELECTRICAL; BLACK WITH ORANGE TRACER; 7 STRAND; 22 AWG; SILVER PLATED COPPER; MILW1687STYPEE22-06 (81349)		FT	V	(A) 1-20	(B) 21-50	(C) 51-100	(A) 1-20	(B) 21-50	(C) 51-100				A1W47
X2-H-- A215	6145-578-6975	...WIRE, ELECTRICAL; VIOLET; 7 STRAND; 22 AWG; SILVER PLATED COPPER; MILW1687STYPEE22-7(81349)		FT	V										A1W48
X2-H-- A216	6145-295-2810	...WIRE, ELECTRICAL; WHITE; 7 STRAND; 20 AWG; SILVER PLATED COPPER; MILW1687STYPEE22-9(81349)		FT	V										A1W49
X2-H-- A217		...WIRE, ELECTRICAL; BLACK; 7 STRAND; 20 AWG; SILVER PLATED COPPER; MILW1687STYPEE22-0(81349)		FT	V										A1W50
X2-H-- A218	6145-581-1625	...WIRE, ELECTRICAL; RED; 7 STRAND; 20 AWG; SILVER PLATED COPPER; MILW1687STYPEE22-2(81349)		FT	V										A1W51
X2-H-- A219		...WIRE, ELECTRICAL; GRAY; 7 STRAND; 20 AWG; SILVER PLATED COPPER; MILW1687STYPEE22-8(81349)		FT	V										A1W52
A--H-R A220	5826-920-7107	...CONTROL, RADIO SET 313N-6C; C6873ARN82(80058) NOTE: SEE TM11-5826-226-34P FIGURE 1, ASSEMBLY A1 FOR PARTS DESCRIPTION AND ILLUSTRATION		EA	1									2	A1A2
P--H-- A418	6625-966-1958	...SIMULATOR, MAGNETIC BEARING; 100101(24363)		EA	1				*	*	*	*	*	2	A1D84
X1-H-- A419	5310-616-8660	...NUT, FLAIN, HEXAGON; SAME AS A030		EA	4									2	A1D84H1
X1-H-- A420	5305-763-6962	...SCREW, MACHINE; MS51959-27(96906)		EA	1									2	A1D84H2
X1-H-- A421	5305-637-1125	...SCREW, MACHINE; MS35214-29(96906)		EA	3									2	A1D84H3
X1-H-- A422	5310-616-3555	...WASHER, LOCK; SAME AS A034		EA	4									2	A1D84H4
X1-H-- H423		...CONNECTOR, PLUG, ELECTRICAL; 100105(24363)		EA	1									9	A1D84J1
X1-H-- A424		...GASKET; 100106(24363)		EA	1									9	A1D84J1H1
X1-H-- A425		...SCREW, MACHINE; 110104-4(24363)		EA	4									9	A1D84J1H2
X1-H-- A426		...WASHER, LOCK; 2101044-4(24363)		EA	4									9	A1D84J1H3
X1-H-- A427		...COVER, FRONT; 100104(24363)		EA	1									9	A1D84MP1
X1-H-- A428		...COVER, FRONT SUBASSEMBLY; 100141(24363)		EA	1									9	A1D84MP2
X1-H-- A429		...DIAL; 100118(24363)		EA	1									9	A1D84MP3
X1-H-- A430		...GASKET, CASE; 100127(24363)		EA	1									9	A1D84MP4

SECTION II DEPOT MAINTENANCE (CONTINUED)

SMR CODE	FEDERAL STOCK NUMBER	DESCRIPTION REFERENCE NUMBER & MFR CODE	USABLE ON CODE	(4) UNIT OF MEAS	(5) QTY INC IN UNIT	(6) 30-DAY DS MAINT ALLOWANCE			(7) 30-DAY GS MAINT ALLOWANCE			(8) 1 YR ALW PER EQUIP COM- TQCY	(9) DEPOT MAINT ALW PER 100 EQUIP	(10) ILLUSTRATIONS	
						(A)	(B)	(C)	(A)	(B)	(C)			(A)	(B)
						1-20	21-50	51-100	1-20	21-50	51-100			FIG NO	ITEM NO OR REFERENCE DESIGNATION
X1-H-- A431		...GEAR, DRIVE: 100110(24363)		EA	1									9	AIDS4MP5
X1-H-- A432		...GEAR, IDLER: 100109(24363)		EA	1									9	AIDS4MP6
X1-H-- A433		...GEAR, SYNCHRO: 100107(24363)		EA	1									9	AIDS4MP7
X1-H-- A434		...GLASS: 100123(24363)		EA	1									9	AIDS4MP8
X1-H-- A435		...HOUSING, REAR: 100102-1(24363)		EA	1									9	AIDS4MP9
X1-H-- A436		...SCREW, MACHINE: 110102-2(24363)		EA	8									9	AIDS4MP9H1
X1-H-- A437		...WASHER, LOCK: 210102-2(24363)		EA	8									9	AIDS4MP2H2
X1-H-- Z438		...HOUSING, SYNCHRO: 100103-2(24363)		EA	1									9	AIDS4MP10
X1-H-- A439		...KNOB: 100113(24363)		EA	1									9	AIDS4MP11
X1-H-- A440		...SETSCREW: 100108-2(24363)		EA	2									9	AIDS4MP1H1
X1-H-- A441		...WASHER, FLAT: 100114(24363)		EA	1									9	AIDS4MP1H2
X1-H-- A442		...NAMEPLATE: 100120-1(24363)		EA	1									9	AIDS4MP12
X1-H-- A443		...POINTER: 100126(24363)		EA	1									9	AIDS4MP13
X1-H-- A444		...SETSCREW: 100106-1(24363)		EA	2									9	AIDS4MP13H1
X1-H-- A445		...RETAINER, DIAL: 100124(24363)		EA	1									9	AIDS4MP14
X1-H-- A446		...SEAL, WINDOW: 100116(24363)		EA	1									9	AIDS4MP15
X1-H-- A447		...SHAFT, SLEEVE: 100125(24363)		EA	1									9	AIDS4MP16
X1-H-- A448		...STUD, GEAR: 100132-1(24363)		EA	1									9	AIDS4MP17
X1-H-- A449		...SYNCHRO: 100121(24363)		EA	1									9	AIDS4MP18
X1-H-- A450		...CLAMP, SYNCHRO 100122(24363)		EA	3									9	AIDS4MP18H1
X1-H-- A451		...SCREW, MACHINE: SAME AS A425		EA	3									9	AIDS4MP18H2
X1-H-- A452		...WASHER, LOCK: SAME AS A426		EA	3									9	AIDS4MP18H3
A--H-R A453A	6625-944-9750	...CASE, ASSEMBLY, TOP: CW878ARM92(80058)	A	EA	1									10	MP2
A--H-R A453		...CASE, ASSEMBLY, TOP CW878ARM92(80058)	B	EA	1									10	MP2
X1-H-- A454		...CASE, TOP: 021-0381-020(74284)		EA	1									10	MP2MP1
A--HOR A455	6625-930-8064	...HARNESSTESTER: TS2501ARM92(80058)		EA	1									10	MP2A1
A--H-R A456		...PANEL ASSEMBLY: 762-1759-001(13499)		EA	1									11	MP2A1A1

SECTION II DEPOT MAINTENANCE (CONTINUED)										(10)				
(1)	(2)	(3)	(4)	(5)	(6)	(7)			(8)	(9)	ILLUSTRATIONS			
SMR CODE	FEDERAL STOCK NUMBER	DESCRIPTION	USABLE ON CODE	UNIT OF MEAS	QTY INC IN UNIT	30-DAY DS MAINT ALLOWANCE			30-DAY GS MAINT ALLOWANCE	1 YR ALW PER EQUIP COM-TCKY	DEPOT MAINT ALW PER 100 EQUIP	(A) FIG NO	(B) ITEM NO OR REFERENCE DESIGNATION	
		REFERENCE NUMBER & MFR CODE			(A)	(B)	(C)	(A)	(B)	(C)				
P--H-- A457	5305-054-5647	...SCREW, MACHINE: SAME AS A074		EA	6			REF	REF	REF	REF	REF	11	MP2A1A1H1
P--H-- A458	5310-933-8118	...WASHER, LOCK: SAME AS A285		EA	6			REF	REF	REF	REF	REF	11	MP2A1A1H2
M--H-- A459		...PANEL: 762-1663-003(13499)		EA	1								12	MP2A1A1MP1
M--H-- A460		...BOARD, WIRED: 762-1759-002(13499)		EA	1								12	MP2A1A1TB1
P--H-- A461	5305-680-6757	...SCREW, MACHINE: SAME AS A077		EA	2			REF	REF	REF	REF	REF	12	MP2A1A1TB1H1
P--H-- A462	5961-053-5445	...SEMICONDUCTOR DEVICE: 1N961B(07688)		EA	1			*	*	*	*	*	12	MP2A1A1TB1CR1
P--H-- A463	5905-965-5558	...RESISTOR, FIXED, FILM: RN55D1962F(81349)		EA	1			*	*	*	*	*	12	MP2A1A1TB1R2
P--H-- A464	5905-965-9116	...RESISTOR, FIXED, FILM: RN55D3322F(81349)		EA	1			*	*	*	*	*	12	MP2A1A1TB1R5
P--H-- A465	5905-965-9052	...RESISTOR, FIXED, FILM: RN55D1002F(81349)		EA	1			*	*	*	*	*	12	MP2A1A1TB1R6
P--H-- A466	5905-686-4528	...RESISTOR, FIXED, COMPOSITIN: RCR07G332KS(81349)		EA	1			*	*	*	*	*	12	MP2A1A1TB1R8
P--H-- A467	5940-204-8298	...TERMINAL BOARD: 1180(88245)		EA	1			*	*	*	*	*	12	MP2A1A1TB1E1
M--H-- A468		...BOARD, WIRED: 762-1759-003(13499)		EA	1								12	MP2A1A1TB2
P--H-- A469	5305-680-6757	...SCREW, MACHINE: SAME AS A077		EA	2			REF	REF	REF	REF	REF	12	MP2A1A1TB2H1
P--H-- A470	5905-988-2317	...RESISTOR, FIXED, FILM: RN60D1001P(81349)		EA	1			*	*	*	*	*	12	MP2A1A1TB2R1
P--H-- A471	5905-988-2317	...RESISTOR, FIXED, FILM: SAME AS A470		EA	1			REF	REF	REF	REF	REF	12	MP2A1A1TB2R4
P--H-- A472	5905-965-9118	...RESISTOR, FIXED, FILM: RN55D5110F(81349)		EA	1			*	*	*	*	*	12	MP2A1A1TB2R3
P--H-- A473	5905-195-5514	...RESISTOR, FIXED, COMPOSITION: RCR20G152KS(81349)		EA	1			*	*	*	*	*	12	MP2A1A1TB2R7
P--H-- A474	5940-204-8298	...TERMINAL BOARD: SAME AS A467		EA	1			REF	REF	REF	REF	REF	12	MP2A1A1TB2E1
P--O-- A475	6240-272-8601	...LAMP, INCANDESCENT: SAME AS A254		EA	1	REF	REF	REF	REF	REF	REF	REF	12	MP2A1A1DS1
P--O-- A476	6240-272-8601	...LAMP, INCANDESCENT: SAME AS A254		EA	1	REF	REF	REF	REF	REF	REF	REF	12	MP2A1A1DS2
P--O-- A477	6240-272-8601	...LAMP, INCANDESCENT: SAME AS A254		EA	1	REF	REF	REF	REF	REF	REF	REF	12	MP2A1A1DS3
P--O-- A478	6240-272-8601	...LAMP, INCANDESCENT: SAME AS A254		EA	1	REF	REF	REF	REF	REF	REF	REF	12	MP2A1A1DS4
P--O-- A479	6240-272-8601	...LAMP, INCANDESCENT: SAME AS A254		EA	1	REF	REF	REF	REF	REF	REF	REF	12	MP2A1A1DS5
P--O-- A480	6240-272-8601	...LAMP, INCANDESCENT: SAME AS A254		EA	1	REF	REF	REF	REF	REF	REF	REF	12	MP2A1A1D6
P--O-- A481	6240-272-8601	...LAMP, INCANDESCENT: SAME AS A254		EA	1	REF	REF	REF	REF	REF	REF	REF	12	MP2A1A1DS7
P--O-- A482	6240-272-8601	...LAMP, INCANDESCENT: SAME AS A254		EA	1	REF	REF	REF	REF	REF	REF	REF	12	MP2A1A1DS8
P--O-- A483	6240-272-8601	...LAMP, INCANDESCENT: SAME AS A254		EA	1	REF	REF	REF	REF	REF	REF	REF	12	MP2A1A1DS9

SECTION II DEPOT MAINTENANCE (CONTINUED)															
(1)	(2)	(3)	(4)	(5)	(6)			(7)			(8)	(9)	(10)		
SMR CODE	FEDERAL STOCK NUMBER	DESCRIPTION	USABLE ON CODE	UNIT OF MEAS	QTY INC IN UNIT	30-DAY DS MAINT ALLOWANCE			30-DAY GS MAINT ALLOWANCE			1 YR ALW PER EQUIP COM-TCKY	DEPOT MAINT ALW PER 100 EQUIP	ILLUSTRATIONS (A) FIG NO	(B) ITEM NO OR REFERENCE DESIGNATION
		REFERENCE NUMBER & MFR CODE				(A)	(B)	(C)	(A)	(B)	(C)				
P--O-- A484	6240-272-8601LAMP, INCANDESCENT; SAME AS A254		EA	1	REF	REF	REF	REF	REF	REF	REF	REF	12	MP2A1A1DS10
P--O-- A485	6240-272-8601LAMP, INCANDESCENT; SAME AS A254		EA	1	REF	REF	REF	REF	REF	REF	REF	REF	12	MP2A1A1DS11
P--O-- A486	6240-272-8601LAMP, INCANDESCENT; SAME AS A254		EA	1	REF	REF	REF	REF	REF	REF	REF	REF	12	MP2A1A1DS12
P--O-- A487	6240-272-8601LAMP, INCANDESCENT; SAME AS A254		EA	1	REF	REF	REF	REF	REF	REF	REF	REF	12	MP2A1A1DS13
P--O-- A488	6240-272-8601LAMP, INCANDESCENT; SAME AS A254		EA	1	REF	REF	REF	REF	REF	REF	REF	REF	12	MP2A1A1DS14
P--O-- A489	6240-272-8601LAMP, INCANDESCENT; SAME AS A254		EA	1	REF	REF	REF	REF	REF	REF	REF	REF	12	MP2A1A1DS15
P--O-- A490	6240-272-8601LAMP, INCANDESCENT; SAME AS A254		EA	1	REF	REF	REF	REF	REF	REF	REF	REF	12	MP2A1A1DS16
P--O-- A491	6240-272-8601LAMP, INCANDESCENT; SAME AS A254		EA	1	REF	REF	REF	REF	REF	REF	REF	REF	12	MP2A1A1DS17
P--H-- A492	6210-813-8265LIGHT, INDICATOR; SAME AS A140		EA	1				REF	REF	REF	REF	REF	12	MP2A1A1XDS1
P--H-- A493	6210-813-8265LIGHT, INDICATOR; SAME AS A140		EA	1				REF	REF	REF	REF	REF	12	MP2A1A1XDS2
P--H-- A494	6210-813-8265LIGHT, INDICATOR; SAME AS A140		EA	1				REF	REF	REF	REF	REF	12	MP2A1A1XDS3
P--H-- A495	6210-813-8265LIGHT, INDICATOR; SAME AS A140		EA	1				REF	REF	REF	REF	REF	12	MP2A1A1XDS4
P--H-- A496	6210-813-8265LIGHT, INDICATOR; SAME AS A140		EA	1				REF	REF	REF	REF	REF	12	MP2A1A1XDS5
P--H-- A497	6210-813-8265LIGHT, INDICATOR; SAME AS A140		EA	1				REF	REF	REF	REF	REF	12	MP2A1A1XDS6
P--H-- A498	6210-813-8265LIGHT, INDICATOR; SAME AS A140		EA	1				REF	REF	REF	REF	REF	12	MP2A1A1XDS7
P--H-- A499	6210-813-8265LIGHT, INDICATOR; SAME AS A140		EA	1				REF	REF	REF	REF	REF	12	MP2A1A1XDS8
P--H-- A500	6210-813-8265LIGHT, INDICATOR; SAME AS A140		EA	1				REF	REF	REF	REF	REF	12	MP2A1A1XDS9
P--H-- A501	6210-813-8265LIGHT, INDICATOR; SAME AS A140		EA	1				REF	REF	REF	REF	REF	12	MP2A1A1XDS10
P--H-- A502	6210-813-8265LIGHT, INDICATOR; SAME AS A140		EA	1				REF	REF	REF	REF	REF	12	MP2A1A1XDS11
P--H-- A503	6210-813-8265LIGHT, INDICATOR; SAME AS A140		EA	1				REF	REF	REF	REF	REF	12	MP2A1A1XDS12
P--H-- A504	6210-813-8265LIGHT, INDICATOR; SAME AS A140		EA	1				REF	REF	REF	REF	REF	12	MP2A1A1XDS13
P--H-- A505	6210-813-8265LIGHT, INDICATOR; SAME AS A140		EA	1				REF	REF	REF	REF	REF	12	MP2A1A1XDS14
P--H-- A506	6210-813-8265LIGHT, INDICATOR; SAME AS A140		EA	1				REF	REF	REF	REF	REF	12	MP2A1A1XDS15
P--H-- A507	6210-813-8265LIGHT, INDICATOR; SAME AS A140		EA	1				REF	REF	REF	REF	REF	12	MP2A1A1XDS16
P--H-- A508	6210-813-8265LIGHT, INDICATOR; SAME AS A140		EA	1				REF	REF	REF	REF	REF	12	MP2A1A1XDS17
P--O-- A509	6210-990-4637LENS, LIGHT, INDICATOR; SAME AS A137		EA	1	REF	REF	REF	REF	REF	REF	REF	REF	11	MP2A1A1E1
P--O-- A510	6210-990-4637LENS, LIGHT, INDICATOR; SAME AS A137		EA	1	REF	REF	REF	REF	REF	REF	REF	REF	11	MP2A1A1E2

SECTION II DEPT MAINTENANCE (CONTINUED)															
(1)	(2)	(3)	(4)	(5)	(6)			(7)			(8)	(9)	(10)		
SMR CODE	FEDERAL STOCK NUMBER	DESCRIPTION	USABLE ON CODE	UNIT OF MEAS	QTY INC IN UNIT	30-DAY DS MAINT ALLOWANCE			30-DAY GS MAINT ALLOWANCE			1 YR ALW PER EQUIP COM-TCKY	DEPOT MAINT ALW PER 100 EQUIP	ILLUSTRATIONS (A) FIG NO	(B) ITEM NO OR REFERENCE DESIGNATION
		REFERENCE NUMBER & MFR CODE				(A) 1-20	(B) 21-50	(C) 51-100	(A) 1-20	(B) 21-50	(C) 51-100				
P--O-- A511	6210-990-4637LENS, LIGHT, INDICATOR: SAME AS A137		EA	1	REF	REF	REF	REF	REF	REF	REF	REF	11	MP2A1A1E3
P--O-- A512	6210-990-4637LENS, LIGHT, INDICATOR: SAME AS A137		EA	1	REF	REF	REF	REF	REF	REF	REF	REF	11	MP2A1A1E4
P--O-- A513	6210-990-4637LENS, LIGHT, INDICATOR: SAME AS A137		EA	1	REF	REF	REF	REF	REF	REF	REF	REF	11	MP2A1A1E5
P--O-- A514	6210-990-4637LENS, LIGHT, INDICATOR: SAME AS A137		EA	1	REF	REF	REF	REF	REF	REF	REF	REF	11	MP2A1A1E6
P--O-- A515	6210-990-4637LENS, LIGHT, INDICATOR: SAME AS A137		EA	1	REF	REF	REF	REF	REF	REF	REF	REF	11	MP2A1A1E7
P--O-- A516	6210-990-4637LENS, LIGHT, INDICATOR: SAME AS A137		EA	1	REF	REF	REF	REF	REF	REF	REF	REF	11	MP2A1A1E8
P--O-- A517	6210-990-4637LENS, LIGHT, INDICATOR: SAME AS A137		EA	1	REF	REF	REF	REF	REF	REF	REF	REF	11	MP2A1A1E9
P--O-- A518	6210-990-4637LENS, LIGHT, INDICATOR: SAME AS A137		EA	1	REF	REF	REF	REF	REF	REF	REF	REF	11	MP2A1A1E10
P--O-- A519	6210-990-4637LENS, LIGHT, INDICATOR: SAME AS A137		EA	1	REF	REF	REF	REF	REF	REF	REF	REF	11	MP2A1A1E11
P--O-- A520	6210-990-4637LENS, LIGHT, INDICATOR: SAME AS A137		EA	1	REF	REF	REF	REF	REF	REF	REF	REF	11	MP2A1A1E12
P--O-- A521	6210-990-4637LENS, LIGHT, INDICATOR: SAME AS A137		EA	1	REF	REF	REF	REF	REF	REF	REF	REF	11	MP2A1A1E13
P--O-- A522	6210-990-4637LENS, LIGHT, INDICATOR: SAME AS A137		EA	1	REF	REF	REF	REF	REF	REF	REF	REF	11	MP2A1A1E14
P--O-- A523	6210-990-4637LENS, LIGHT, INDICATOR: SAME AS A137		EA	1	REF	REF	REF	REF	REF	REF	REF	REF	11	MP2A1A1E15
P--O-- A524	6210-990-4637LENS, LIGHT, INDICATOR: SAME AS A137		EA	1	REF	REF	REF	REF	REF	REF	REF	REF	11	MP2A1A1E16
P--O-- A525	6210-990-4637LENS, LIGHT, INDICATOR: SAME AS A137		EA	1	REF	REF	REF	REF	REF	REF	REF	REF	11	MP2A1A1E17
P--H-- A526	5935-685-9861CONNECTOR, RECEPTACLE, PT02A12-10P(77820)		EA	1				*	*	*	*	*	11	MP2A1A1J1
P--H-- A527	5310-208-3786NUT, PLAIN, HEXAGON: SAME AS A031		EA	4				REF	REF	REF	REF	REF	11	MP2A1A1J1H1
P--H-- A528	5305-054-5648SCREW, MACHINE: SAME AS A109		EA	4				REF	REF	REF	REF	REF	11	MP2A1A1J1H2
P--H-- A529	5310-933-8118WASHER, LOCK* SAME AS A285		EA	4				REF	REF	REF	REF	REF	11	MP2A1A1J1H3
P--H-- A530	5935-988-3616CONNECTOR, RECEPTACLE: SAME AS A383		EA	1				REF	REF	REF	REF	REF	11	MP2A1A1J2
P--H-- A531	5310-208-3786NUT, PLAIN, HEXAGON: SAME AS A031		EA	4				REF	REF	REF	REF	REF	11	MP2A1A1J2H1
P--H-- A532	5305-054-5648SCREW, MACHINE SAME AS A109		EA	4				REF	REF	REF	REF	REF	11	MP2A1A1J2H2
P--H-- A533	5310-933-8118WASHER, LOCK: SAME AS A285		EA	4				REF	REF	REF	REF	REF	11	MP2A1A1J2H3
A--H-R A534	BOX, MODIFIED: 762-1663-001(13499)		EA	1									11	MP2A1MP1
M--H-- A535	BOX, DRANN ALUMINUM: Z80-96-17(98376)		EA	1									11	MP2A1MP1MP1
P--H-- A536	5340-931-5548CATCH, LUGGAGE VHC340(98003)		EA	2				*	*	*	*	*	11	MP2A1MP1MP2
P--H-- A537	5320-117-6937RIVET, SOLID: MS20426AD3-3(96906)		EA	4				*	*	*	*	*	11	MP2A1MP1MP2H1

SECTION II DEPOT MAINTENANCE (CONTINUED)										
(1)	(2)	(3)	(4)	(5)	(6)	(7)	(8)	(9)	(10)	
SMR CODE	FEDERAL STOCK NUMBER	DESCRIPTION	USABLE ON CODE	UNIT OF MEAS	QTY INC IN UNIT	30-DAY DS MAINT ALLOWANCE	30-DAY GS MAINT ALLOWANCE	1 YR ALW PER EQUIP COM-TGCY	DEPOT MAINT ALW PER 100 EQUIP	ILLUSTRATIONS (A) FIG NO (B) ITEM NO OR REFERENCE DESIGNATION
		REFERENCE NUMBER & MFR CODE				(A) (B) (C)	(A) (B) (C)			
P--H-- A538	5841-510-0834	... INSERT-TAPPED 4-40: 504-9478-002(13499)		EA	6		* * *	*	11	MP2A1MP1H2
X1-H-- A539		... COVER, MODIFIED: 762-1663-002(13499)		EA	1				11	MP2A1MP2
M--H-- A540		... COVER, BOX, DRAWN ALUMINUM: Z80-96CF14(98376)		EA	1				11	MP2A1MP2MP1
P--H-- A541	5340-021-4713	... CATCH, LUGGAGE: VHS340(98003)		EA	2		* * *	*	11	MP2A1MP2MP2
P--H-- A542	5320-117-6937	... RIVET, SOLID: SAME AS A537		EA	4		REF REF REF	REF	11	MP2A1MP2MP2H1
M--H-- A543		... PLATE, IDENTIFICATIN: 762-1736-005(13499)		EA	1				11	MP2A1MP3
P--H-- A544	5305-054-5635	... SCREW MACHINE SAME AS A145		EA	2		REF REF REF	REF	11	MP2A1MP3H1
P--H-- A545	5340-616-3973	... BUMPER, RUBBER, RECESSED: 747BLACK(75543)		EA	4		* * *	*	3	MP2A1MP4
P--H-- A546	5310-616-8660	... NUT, PLAIN, HEXAGON: SAME AS A030		EA	4		REF REF REF	REF	3	MP2A1MP4H1
P--H-- A547	5305-054-6653	... SCREW, MACHINE: SAME AS A005		EA	4		REF REF REF	REF	3	MP2A1MP4H2
P--H-- A548	5310-616-3555	... WASHER, LOCK: SAME AS A034		EA	4		REF REF REF	REF	3	MP2A1MP4H3
M--H-- A549		... HOLDER, HARNESS 762-1559-001(13499)		EA	1				10	MP2MP2
M--H-- A550		... PLATE, IDENTIFICATIN: 616-5564-000(13499)		EA	1				10	MP2MP3
P--H-- A551	5320-817-0728	... RIVET, TUBULAR: MS16535-53(96906)		EA	2		* * *	*	10	MP2MP3H1
M--H-- A552		... PLATE, IDENTIFICATIN: 616-5650-000		EA	1				10	MP2MP4
P--H-- A553	5320-817-0728	... RIVET, TUBULAR: SAME AS A551		EA	2		REF REF REF	REF	10	MP2MP4H1

SECTION III INDEX-FEDERAL STOCK NUMBER AND REFERENCE NUMBER

CROSS REFERENCE TO FIGURE AND ITEM NUMBER

FEDERAL STOCK NUMBER	FIGURE NUMBER	ITEM NUMBER OR REF DESIGNATION	FEDERAL STOCK NUMBER	FIGURE NUMBER	ITEM NUMBER OR REF DESIGNATION
53050545635	2	A1MP6H1	53105503713	4	A1A1H6
	11	MP2A1MP3H1		5	A1A1J5H3
53050545647	5	A1A1TB1H2		5	A1A1K1H2
	5	A1A1E5H1		5	A1A1K2H2
	11	MP2A1A1H1		5	A1A1TB1H3
53050545648	7	A1J4H2		5	A1A1E5H2
	11	MP2A1A1J1H2		5	A1A1T1H2
	11	MP2A1A1J2H2		7	A1J4H4
53050545649	5	A1A1J5H2		6	A1MP7H3
	7	A1J4H3		6	A1MP8H3
53050546651	2	A1H1	53106163555	4	A1A1H5
53050546653	3	MP1MP1H2		5	A1A1MP2H3
	3	MP1MP2H2		5	A1A1T2H2
	3	MP1MP4H2		2	A1DS4H4
	3	MP2A1MP4H2		3	MP2A1MP4H3
53050546654	5	A1A1MP2H2	53106168660	4	A1A1H1
	4	A1A1MP3H2		5	A1A1MP2H1
	5	A1A1MP4H2		5	A1A1T2H1
	5	A1A1MP5H2		2	A1DS4H1
53050598255	2	A1A3H1		3	MP2A1MP4H1
53052061288	2	A1A4H1	53106768573	5	A1A1TB2H2
53056371125	2	A1DS4H3	53108575547	3	MP1MP1H1
53056806757	5	A1A1TB2H1		3	MP1MP2H1
	12	MP2A1A1TB1H1		3	MP1MP4H1
	12	MP2A1A1TB2H1		4	A1A1MP3H1
53057636962	2	A1DS4H2		5	A1A1MP4H1
53057636963	4	A1A1H4		5	A1A1MP5H1
	6	A1T3H2	53108835931	5	A1A1R1H2
53057637822	4	A1A1H3		7	A1J3H2
53057702579	6	A1MP7H2		7	A1S1H2
	6	A1MP8H2		7	A1S2H2
53100531551	5	A1A1TB1H1		7	A1S3H2
53102083786	4	A1A1H2		7	A1S5H2
	5	A1A1J5H1	53109338118	11	MP2A1A1H2
	5	A1A1K1H1		11	MP2A1A1J1H3
	5	A1A1K2H1		11	MP2A1A1J2H3
	5	A1A1T1H1	53201176937	11	MP2A1MP1MP2H1
	7	A1J4H1		11	MP2A1MP2MP2H1
	6	A1MP7H1	53205840672	3	MP1MP5H1
	6	A1MP8H1	53208170728	10	MP2MP3H1
	11	MP2A1A1J1H1		10	MP2MP4H1
	11	MP2A1A1J2H1	53251714365	3	MP1MP5
53102084662	5	A1A1R1H1	53400214713	11	MP2A1MP2MP2
	7	A1J3H1	53402002691	4	A1A1MP3
	7	A1S1H1	53403368164	5	A1A1MP5
	7	A1S2H1	53405980296	5	A1A1MP4
	7	A1S3H1	53406163973	3	MP2A1MP4
	7	A1S5H1	53408034705	5	A1A1MP2
53102751347	2	A1H2	53408196857	6	A1T3H1
53105319514	3	MP1MP1H3	53409315548	11	MP2A1MP1MP2

SECTION III INDEX-FEDERAL STOCK NUMBER AND REFERENCE NUMBER

CROSS REFERENCE TO FIGURE AND ITEM NUMBER (CONTINUED)

FEDERAL STOCK NUMBER	FIGURE NUMBER	ITEM NUMBER OR REF DESIGNATION	FEDERAL STOCK NUMBER	FIGURE NUMBER	ITEM NUMBER OR REF DESIGNATION
53555791210	2	A1MP4	59358271336	7	A1J4
53556801357	2	A1MP2	59358662254	6	A1W4P6
	2	A1MP3	59358662255	3	A1W2P2
	2	A1MP1		6	A1W3P5
58261688397	2	A1A4	59359883616	11	MP2A1A1J2
58265053094	7	A1A3	59400610050	5	A1A1E5
58269207107	2	A1A2	59402048298	12	MP2A1A1TB1E1
58415100834	11	MP2A1MP1H2		12	MP2A1A1TB2E1
59050690897	5	A1A1R3	59402692219	7	A1J2
59051955514	12	MP2A1A1TB2R7	59403562493	7	A1J1
59056811197	5	A1A1R1	59405499610	5	A1A1TB2
59056864528	12	MP2A1A1TB1R8	59406655592	6	A1E10
59057301489	5	A1A1R6		6	A1E20
	5	A1A1R7	59408473138	5	A1A1E1
59058168554	5	A1A1R4		5	A1A1E2
59059059356	5	A1A1R5		5	A1A1E3
59059655558	12	MP2A1A1TB1R2		5	A1A1E4
59059659052	12	MP2A1A1TB1R6	59455007924	5	A1A1K1
59059659116	12	MP2A1A1TB1R5	59456852905	5	A1A1K2
59059659118	12	MP2A1A1TB2R3	59507389448	5	A1A1T2
59059882313	5	A1A1R2		6	A1T3
59059882314	6	A1R8	59509034357	5	A1A1T1
59059882317	12	MP2A1A1TB2R1	59610535445	12	MP2A1A1TB1CR1
	12	MP2A1A1TB2R4	59610876047	5	A1A1CR2
59202808342	2	A1F2	59618532607	5	A1A1CR1
	2	A1F3	59618920889	5	A1A1CR1
	2	A1F5	61450609078		A1W19
	2	A1F6	61450609083		A1W16
59204746125	2	A1F1	61451604775		A1W6
	2	A1F4	61452952810		A1W49
59208929311	7	A1XF1	61455480969		A1W8
	7	A1XF2	61455573591		A1W45
	7	A1XF3			A1W43
	7	A1XF4	61455786975		A1W48
	7	A1XF5	61455786978		A1W46
	7	A1XF6	61455811625		A1W51
59308149176	6	A1S4	61455819324	A1W44	
59309660859	8	A1S3	61456237224		A1W40
59351493427	5	A1A1J5	61456237225		A1W42
59351962234	6	A1W1P1	61456864916		A1W27
	6	A1P1	61456864917		A1W26
59352230572	6	A1P4MP1	61456864937		A1W14
59352802195	6	A1P1MP1	61456864939		A1W12
59354156070	7	A1J3	61456864941		A1W10
59355522374	6	A1P4	61456864952		A1W23
59356664860	6	A1W1MP1	61456864954		A1W20
59356859861	11	MP2A1A1J1	61456865274		A1W18
59356869523	2	A1MP9	61457253081		A1W28
59357298688	3	A1W2P3	61457548057		A1W39

SECTION III INDEX-FEDERAL STOCK NUMBER AND REFERENCE NUMBER

CROSS REFERENCE TO FIGURE AND ITEM NUMBER (CONTINUED)

FEDERAL STOCK NUMBER	FIGURE NUMBER	ITEM NUMBER OR REF DESIGNATION	FEDERAL STOCK NUMBER	FIGURE NUMBER	ITEM NUMBER OR REF DESIGNATION
61457548058		A1W41	62109904637	11	MP2A1A1E7
61458389444		A1W5		11	MP2A1A1E8
61458412913		A1W17		11	MP2A1A1E9
61458413247		A1W21		11	MP2A1A1E10
61459289896		A1W22		11	MP2A1A1E11
61459294205		A1W33		11	MP2A1A1E12
61459521735		A1W24		11	MP2A1A1E13
61459657068		A1W37		11	MP2A1A1E14
61459657071		A1W36		11	MP2A1A1E15
61459657072		A1W35		11	MP2A1A1E16
61459657073		A1W34		11	MP2A1A1E17
61459657076		A1W30	62401557836	2	A1DS1
61459657078		A1W29		2	A1DS2
61459657093		A1W32		2	A1DS3
62108138265	7	A1XDS1	62402728601	12	MP2A1A1DS1
	7	A1XDS2		12	MP2A1A1DS2
	7	A1XDS3		12	MP2A1A1DS3
	12	MP2A1A1XDS1		12	MP2A1A1DS4
	12	MP2A1A1XDS2		12	MP2A1A1DS5
	12	MP2A1A1XDS3		12	MP2A1A1DS6
	12	MP2A1A1XDS4		12	MP2A1A1DS7
	12	MP2A1A1XDS5		12	MP2A1A1DS8
	12	MP2A1A1XDS6		12	MP2A1A1DS9
	12	MP2A1A1XDS7		12	MP2A1A1DS10
	12	MP2A1A1XDS8		12	MP2A1A1DS11
	12	MP2A1A1XDS9		12	MP2A1A1DS12
	12	MP2A1A1XDS10		12	MP2A1A1DS13
	12	MP2A1A1XDS11		12	MP2A1A1DS14
	12	MP2A1A1XDS12		12	MP2A1A1DS15
	12	MP2A1A1XDS13		12	MP2A1A1DS16
	12	MP2A1A1XDS14		12	MP2A1A1DS17
	12	MP2A1A1XDS15	66251592399	2	1
	12	MP2A1A1XDS16		2	A1
	12	MP2A1A1XDS17	66258429720	2	A1M1
62109904637	2	A1E1	66259308064	10	MP2A1
	2	A1E2	66259449758	6	A1W1
	2	A1E3	66259661932	2	A1M3
	11	MP2A1A1E1	66259661933	2	A1M2
	11	MP2A1A1E2	66259661958	2	A1DS4
	11	MP2A1A1E3	66259995118	1	1
	11	MP2A1A1E4			
	11	MP2A1A1E5			
	11	MP2A1A1E6			

SECTION III INDEX-FEDERAL STOCK NUMBER AND REFERENCE NUMBER

CROSS REFERENCE TO FIGURE AND ITEM NUMBER (CONTINUED)

REFERENCE CODE	MFG	FIG NO	ITEM NO	REFERENCE NO	MFG CODE	FIG NO	ITEM NO
ANARM92	80058	1	1	MILW16878TYPEE22	81349		A1W16
ANARM92A	80058	2	1				A1W17
BC3258	97315	5	A1A1T1				A1W18
BT02A20-41P	09922	11	MP2A1A1J2				A1W19
CW878ARM92	80058	10	MP2				A1W20
CX11568ARM92	13499	6	A1W1				A1W21
C6873ARN82	80058	2	A1A2				A1W22
DF30BC	58474	7	A1J2				A1W23
DF30RC	58474	7	A1J1				A1W24
F02A250V1AS	81349	2	A1F2				A1W25
F02A250V1AS	81349	2	A1F3				A1W26
F02A250V1AS	81349	2	A1F5				A1W27
F02A250V1AS	81349	2	A1F6				A1W28
F02A250V2AS	81349	2	A1F1				A1W29
F02A250V2AS	81349	2	A1F4				A1W30
HKPH	71400	7	A1XF1				A1W31
HKPH	71400	7	A1XF2				A1W32
HKPH	71400	7	A1XF3				A1W33
HKPH	71400	7	A1XF4				A1W34
HKPH	71400	7	A1XF5				A1W35
HKPH	71400	7	A1XF6				A1W36
HP10N	09922	5	A1A1MP5				A1W37
HP5N	09922	5	A1A1MP2				A1W38
HP6N	09922	4	A1A1MP3				A1W39
HP7N	09922	5	A1A1MP4				A1W40
ID1347AARN82	80058	2	A1A4				A1W41
ID1347ARN82	80058	2	A1A4				A1W42
ID250AARN	80058	7	A1A3				A1W43
JAN1N198M	81350	5	A1A1CR1				A1W44
JAN1N938B	81349	5	A1A1CR1				A1W45
MILW16878TYPEE20	81349		A1W49				A1W46
			A1W50				A1W47
			A1W51				A1W48
			A1W52	MS16535-53	96906	10	MP2MP3H1
MILW16878TYPEE22	81349		A1W8			10	MP2MP4H1
			A1W9	MS20426AD3-3	96906	11	MP2A1MP1MP2H1
			A1W10			11	MP2A1MP2MP2H1
			A1W11	MS20426AD3-6	96906	3	MP1MP5H1
			A1W12	MS25237-327	96906	2	A1DS1
			A1W13			2	A1DS2
			A1W14			2	A1DS3
			A1W15	MS25237-327R	96906	12	MP2A1A1DS1

SECTION III INDEX-FEDERAL STOCK NUMBER AND REFERENCE NUMBER

CROSS REFERENCE TO FIGURE AND ITEM NUMBER (CONTINUED)

REFERENCE CODE	MFG	FIG NO	ITEM NO	REFERENCE NO	MFG CODE	FIG NO	ITEM NO
MS25237-327R	96906	12	MP2A1A1DS2	MS35338-135	96906	11	MP2A1A1J2H3
		12	MP2A1A1DS3	MS51957-1	96906	2	A1MP6H1
		12	MP2A1A1DS4			11	MP2A1MP3H1
		12	MP2A1A1DS5	MS51957-13	96906	5	A1A1TB1H2
		12	MP2A1A1DS6			5	A1A1E5H1
		12	MP2A1A1DS7			11	MP2A1A1H1
		12	MP2A1A1DS8	MS51957-14	96906	7	A1J4H2
		12	MP2A1A1DS9			11	MP2A1A1J1H2
		12	MP2A1A1DS10			11	MP2A1A1J2H2
		12	MP2A1A1DS11	MS51957-15	96906	5	A1A1J5H2
		12	MP2A1A1DS12			7	A1J4H3
		12	MP2A1A1DS13	MS51957-27	96906	2	A1H1
		12	MP2A1A1DS14	MS51957-29	96906	3	MP1MP1H2
		12	MP2A1A1DS15			3	MP1MP2H2
		12	MP2A1A1DS16			3	MP1MP4H2
		12	MP2A1A1DS17			3	MP2A1MP4H2
		MS3057-12A	96906	6	A1P4MP1	MS51957-30	96906
MS3057-6A	96906	6	A1P1MP1			4	A1A1MP3H2
MS3102A14S5P	96906	5	A1A1J5			5	A1A1MP4H2
MS3106A14S5S	96906	6	A1W1P1			5	A1A1MP5H2
		6	A1P1	MS51959-14	96906	4	A1A1H3
MS3106A22-14S	96906	6	A1P4	MS51959-15	96906	6	A1MP7H2
MS35214-27	96906	2	A1A4H1			6	A1MP8H2
MS35214-29	96906	2	A1DS4H3	MS51959-27	96906	2	A1DS4H2
MS35214-30	96906	2	A1A3H1	MS51959-28	96906	4	A1A1H4
MS35333-70	96906	4	A1A1H6			6	A1T3H2
		5	A1A1J5H3	MS91528-1F2B	96906	2	A1MP2
		5	A1A1K1H2			2	A1MP3
		5	A1A1K2H2			2	A1MP1
		5	A1A1TB1H3	MS91528-3F2B	96906	2	A1MP4
		5	A1A1E5H2	NAS671C4	80205	4	A1A1H2
		5	A1A1T1H2			5	A1A1J5H1
		7	A1J4H4			5	A1A1K1H1
		6	A1MP7H3			5	A1A1K2H1
		6	A1MP8H3			5	A1A1T1H1
MS35333-71	96906	4	A1A1H5			7	A1J4H1
		5	A1A1MP2H3			6	A1MP7H1
		5	A1A1T2H2			6	A1MP8H1
		2	A1DS4H4			11	MP2A1A1J1H1
		3	MP2A1MP4H3			11	MP2A1A1J2H1
MS35338-135	96906	11	MP2A1A1H2	PT02A12-10P	77820	11	MP2A1A1J1
MS35338-135	96906	11	MP2A1A1J1H3	PT02A14-19P	77820	7	A1J4

SECTION III INDEX-FEDERAL STOCK NUMBER AND REFERENCE NUMBER

CROSS REFERENCE TO FIGURE AND ITEM NUMBER (CONTINUED)

REFERENCE CODE	MFG	FIG NO	ITEM NO	REFERENCE NO	MFG CODE	FIG NO	ITEM NO
PT06A12-10SSR	77820	3	A1W2P3	Z80-96CF14	98376	11	MP2A1MP2MP1
PT06A14-19SSR	77820	6	A1W4P6	021-0381-020	74284	10	MP2MP1
PT06A20-41SSR	77820	3	A1W2P2	021-0381-030	74284	3	MP1MP3
		6	A1W3P5	1N645	07688	5	A1A1CR2
P313-0045-000	77250	4	A1A1H1	1N961B	07688	12	MP2A1A1TB1CR1
		5	A1A1MP2H1	10-101960-143	77820	2	A1MP9
		5	A1A1T2H1	100101	24363	2	A1DS4
		2	A1DS4H1	100102-1	24363	9	A1DS4MP9
		3	MP2A1MP4H1	100103-2	24363	9	A1DS4MP10
P313-0062-000	77250	5	A1A1R1H1	100104	24363	9	A1DS4MP1
		7	A1J3H1	100105	24363	9	A1DS4J1
		7	A1S1H1	100106	24363	9	A1DS4J1H1
		7	A1S2H1	100107	24363	9	A1DS4MP7
		7	A1S3H1	100108-1	24363	9	A1DS4MP13H1
		7	A1S5H1	100108-2	24363	9	A1DS4MP11H1
P343-0386-000	77250	5	A1A1TB2H1	100109	24363	9	A1DS4MP6
		12	MP2A1A1TB1H1	100110	24363	9	A1DS4MP5
		12	MP2A1A1TB2H1	100113	24363	9	A1DS4MP11
RA20LASB102A	81349	5	A1A1R1	100114	24363	9	A1DS4MP11H2
RCR07G103KS	81349	5	A1A1R4	100116	24363	9	A1DS4MP15
RCR07G332KS	81349	12	MP2A1A1TB1R8	10018	24363	9	A1DS4MP3
RCR20G152KS	81349	12	MP2A1A1TB2R7	100120-1	24363	9	A1DS4MP12
RL07S472J	81349	5	A1A1R6	100121	24363	9	A1DS4MP18
		5	A1A1R7	100122	24363	9	A1DS4MP18H1
RL32S271G	81349	5	A1A1R5	100123	24363	9	A1DS4MP8
RN55D1002F	81349	12	MP2A1A1TB1R6	100124	24363	9	A1DS4MP14
RN55D1962F	81349	12	MP2A1A1TB1R2	100125	24363	9	A1DS4MP16
RN55D3322F	81349	12	MP2A1A1TB1R5	100126	24363	9	A1DS4MP13
RN55D5110F	81349	12	MP2A1A1TB2R3	100127	24363	9	A1DS4MP4
RN60D1001F	81349	12	MP2A1A1TB2R1	100132-1	24363	9	A1DS4MP17
		12	MP2A1A1TB2R4	100141	24363	9	A1DS4MP2
RN60D1211F	81349	5	A1A1R2	110102-2	24363	9	A1DS4MP9H1
RN60D2000F	81349	6	A1R8	110104-4	24363	9	A1DS4J1H2
RN60D3740F	81349	5	A1A1R3			9	A1DS4MP18H2
RTMT16M	91663	5	A1A1E5	1180	88245	12	MP2A1A1TB1E1
TS2500AARM92	80058	2	A1		88245	12	MP2A1A1TB2E1
TS2500ARM92	80058	2	A1	1181	06481	5	A1A1TB2
TS2501ARM92	80058	10	MP2A1	1203-00	78189	5	A1A1TB2H2
VHC340	98003	11	MP2A1MP1MP2	162-0931	72619	2	A1E1
VHS340	98003	11	MP2A1MP2MP2			2	A1E2
WTE26A	90484	0	A1W7			2	A1E3
Z80-96-17	98376	11	MP2A1MP1MP1			11	MP2A1A1E1

SECTION III INDEX-FEDERAL STOCK NUMBER AND REFERENCE NUMBER

CROSS REFERENCE TO FIGURE AND ITEM NUMBER (CONTINUED)

REFERENCE CODE	MFG	FIG NO	ITEM NO	REFERENCE NO	MFG CODE	FIG NO	ITEM NO
162-0931	72619	11	MP2A1A1E2	1720-02	78189	7	A1S5H2
	72619	11	MP2A1A1E3	210102-2	24363	9	A1DS4MP9H2
	72619	11	MP2A1A1E4	210104-4	24363	9	A1DS4J1H3
	72619	11	MP2A1A1E5		24363	9	A1DS4MP18H3
	72619	11	MP2A1A1E6	2104-04-01-2520N	78189	5	A1A1E1
	72619	11	MP2A1A1E7		78189	5	A1A1E2
	72619	11	MP2A1A1E8		78189	5	A1A1E3
	72619	11	MP2A1A1E9		78189	5	A1A1E4
	72619	11	MP2A1A1E10	212-12N	71286	3	MP1MP5
	72619	11	MP2A1A1E11	22700-19	80089	5	A1A1K2
	72619	11	MP2A1A1E12	22700-20	80089	5	A1A1K1
	72619	11	MP2A1A1E13	30YY2068	81073	6	A1S4
	72619	11	MP2A1A1E14	310-0046-000	79807	2	A1H2
	72619	11	MP2A1A1E15	310-6360-000	79807	3	MP1MP1H3
	72619	11	MP2A1A1E16	36747	73386	5	A1A1T2
	72619	11	MP2A1A1E17		73386	6	A1T3
162-8430-09-502	72619	7	A1XDS1	4-03649-0210	70674	7	A1J3
	72619	7	A1XDS2	4012HT	78189	6	A1E1
	72619	7	A1XDS3		78189	6	A1E2
	72619	12	MP2A1A1XDS1	421-0074-000	94130	0	A1W5
	72619	12	MP2A1A1XDS2	421-2220-000	94130	0	A1W6
	72619	12	MP2A1A1XDS3	44A30-01-4-2N	81073	7	A1S1
	72619	12	MP2A1A1XDS4		81073	8	A1S2
	72619	12	MP2A1A1XDS5	44A30-02-4-2N	81073	7	A1S2
	72619	12	MP2A1A1XDS6	44A30-03-4-2N	81073	7	A1S5
	72619	12	MP2A1A1XDS7	44A30-08-1-12N	81073	7	A1S3
	72619	12	MP2A1A1XDS8	504-9478-002	13499	11	MP2A1MP1H2
	72619	12	MP2A1A1XDS9	540-9041-003	13499	5	A1A1TB1H1
	72619	12	MP2A1A1XDS10	540-9217-003	13499	6	A1T3H1
	72619	12	MP2A1A1XDS11	616-5562-000	13499	1	A1MP6
	72619	12	MP2A1A1XDS12	616-5564-000	13499	10	MP2MP3
	72619	12	MP2A1A1XDS13	616-5650-000	13499	10	MP2MP4
	72619	12	MP2A1A1XDS14	616-5651-001	13499	2	A1MP6
	72619	12	MP2A1A1XDS15	68NM62	72962	3	MP1MP1H1
	72619	12	MP2A1A1XDS16		72962	3	MP1MP2H1
	72619	12	MP2A1A1XDS17		72962	3	MP1MP4H1
162680H2	76854	8	A1S3		72962	4	A1A1MP3H1
1720-02	78189	5	A1A1R1H2		72962	5	A1A1MP4H1
1720-02	78189	7	A1J3H2		72962	5	A1A1MP5H1
1720-02	78189	7	A1S1H2	7213	55026	2	A1M1
1720-02	78189	7	A1S2H2	747RBLACK	75543	3	MP2A1MP4
1720-02	78189	7	A1S3H2	762-1553-002	13499	3	MP1MP2

SECTION III INDEX-FEDERAL STOCK NUMBER AND REFERENCE NUMBER

CROSS REFERENCE TO FIGURE AND ITEM NUMBER (CONTINUED)

REFERENCE CODE	MFG	FIG NO	ITEM NO	REFERENCE NO	MFG CODE	FIG NO	ITEM NO
762-1554-002	13499	1	A1MP5	762-1707-010	13499	4	A1A1
762-1554-010	13499	2	A1MP5	762-1708-001	13499	6	A1W3
762-1555-002	13499	3	MP1	762-1708-002	13499	6	A1W4
762-1556-001	13499	6	A1MP7	762-1715-000	13499	5	A1A1MP6
	13499	6	A1MP8	762-1736-005	13499	11	MP2A1MP3
762-1559-001	13499	10	MP2MP2	762-1759-001	13499	11	MP2A1A1
762-1564-002	13499	3	MP1MP1	762-1759-002	13499	12	MP2A1A1TB1
762-1565-002	13499	3	MP1MP4	762-1759-003	13499	12	MP2A1A1TB2
762-1663-001	13499	11	MP2A1MP1	772-1661-001	13499	5	A1A1MP1
762-1663-002	13499	11	MP2A1MP2	8185	55026	2	A1M2
762-1663-003	13499	12	MP2A1A1MP1	8186	55026	2	A1M3
762-1664-001	13499	3	A1W2	97-3057-6	02660	6	A1W1MP1
762-1677-002	13499	5	A1A1TB1				
762-1707-001	13499	4	A1A1				























SECTION IV INDEX-REFERENCE DESIGNATION CROSS-REFERENCE TO PAGE NUMBER

REFERENCE DESIGNATION	PAGE NO	REFERENCE DESIGNATION	PAGE NO	REFERENCE DESIGNATION	PAGE NO
A1		A1A1MP5H1		A1DS4J1H3	15
A1	5	A1A1MP5I2	6	A1DS4MP1	15
A1A1		A1A1MP6	6	A1DS4MP10	16
A1A1	5	A1A1P1	7	A1DS4MP11	16
A1A1CR1	7	A1A1R1H1	7	A1DS4MP11H1	16
A1A1CR1	7	A1A1R1H2	7	A1DS4MP11H2	16
A1A1CR2	7	A1A1R2	7	A1DS4MP12	16
A1A1E1	7	A1A1R3	7	A1DS4MP13	16
A1A1E2	7	A1A1R4	7	A1DS4MP13H1	16
A1A1E3	7	A1A1R5	7	A1DS4MP14	16
A1A1E4	8	A1A1R6	7	A1DS4MP15	16
A1A1E5	8	A1A1R7	7	A1DS4MP16	16
A1A1E5H1	8	A1A1TB1	7	A1DS4MP17	16
A1A1E5H2	8	A1A1TB1H1	7	A1DS4MP18	16
A1A1H1	5	A1A1TB1H2	7	A1DS4MP18H1	16
A1A1H2	6	A1A1TB1H3	7	A1DS4MP18H2	16
A1A1H3	6	A1A1TB2	7	A1DS4MP18H3	16
A1A1H4	6	A1A1TB2H1	7	A1DS4MP2	15
A1A1H5	6	A1A1TB2H2	7	A1DS4MP3	15
A1A1H6	6	A1A1T1	8	A1DS4MP4	15
A1A1J5	6	A1A1T1H1	8	A1DS4MP5	16
A1A1J5H1	6	A1A1T1H2	8	A1DS4MP6	16
A1A1J5H2	6	A1A1T2	8	A1DS4MP7	16
A1A1J5H3	6	A1A1T2H1	8	A1DS4MP8	16
A1A1K1	6	A1A1T2H2	8	A1DS4MP9	16
A1A1K1H1	7	A1A2	15	A1DS4MP9H1	16
A1A1K1H2	7	A1A3	9	A1DS4MP9H2	16
A1A1K2	7	A1A3H1	9	A1E1	10
A1A1K2H1	7	A1A4	9	A1E10	11
A1A1K2H2	7	A1A4	9	A1E2	10
A1A1MP1	6	A1A4H1	9	A1E20	11
A1A1MP2	6	A1DS1	10	A1E3	10
A1A1MP2H1	6	A1DS2	10	A1F1	9
A1A1MP2H2	6	A1DS3	10	A1F2	9
A1A1MP2H3	6	A1DS4	15	A1F3	9
A1A1MP3	6	A1DS4H1	15	A1F4	9
A1A1MP3H1	6	A1DS4H2	15	A1F5	9
A1A1MP3H2	6	A1DS4H3	15	A1F6	9
A1A1MP4	6	A1DS4H4	15	A1H1	5
A1A1MP4H1	6	A1DS4J1	15	A1H2	5
A1A1MP4H2	6	A1DS4J1H1	15	A1J1	10
A1A1MP5	6	A1DS4J1H2	15	A1J2	10

SECTION IV INDEX-REFERENCE DESIGNATION CROSS-REFERENCE TO PAGE NUMBER (CONTINUED)

REFERENCE DESIGNATION	PAGE NO	REFERENCE DESIGNATION	PAGE NO	REFERENCE DESIGNATION	PAGE NO
A1J3	9	A1S3	11	A1W34	14
A1J3H1	10	A1S3H1	11	A1W35	14
A1J3H2	10	A1S3H2	11	A1W36	14
A1J4	9	A1S4	11	A1W37	14
A1J4H1	9	A1S5	11	A1W38	14
A1J4H2	9	A1S5H1	11	A1W39	14
A1J4H3		A1S5H2	11	A1W4	8
A1J4H4	9	A1T3	11	A1W4P6	8
A1MP1	10	A1T3H1	11	A1W40	14
A1MP2	10	A1T3H2	11	A1W41	14
A1MP3	10	A1W1	8	A1W42	14
A1MP4	10	A1W1MP1	8	A1W43	14
A1MP5	10	A1W1P1	8	A1W44	14
A1MP6	10	A1W10	12	A1W45	14
A1MP6	10	A1W11	12	A1W46	14
A1MP6H1	10	A1W12	12	A1W47	15
A1MP7	10	A1W13	12	A1W48	15
A1MP7H1	10	A1W14	12	A1W49	15
A1MP7H2	10	A1W15	12	A1W5	11
A1MP7H3	10	A1W16	12	A1W50	15
A1MP8	11	A1W17	12	A1W51	15
A1MP8H1	11	A1W18	12	A1W52	15
A1MP8H2	11	A1W19	12	A1W6	12
A1MP8H3	11	A1W2	8	A1W7	12
A1MP9	8	A1W2P2	8	A1W8	12
A1M1	5	A1W2P3	8	A1W9	12
A1M2	5	A1W20	13	A1XDS1	10
A1M3	5	A1W21	13	A1XDS2	10
A1P1	8	A1W22	13	A1XDS3	10
A1P1MP1		A1W23	13	A1XF1	9
A1P4	9	A1W24	13	A1XF2	9
A1P4MP1	9	A1W25	13	A1XF3	9
A1R8	11	A1W26	13	A1XF4	9
A1S1	11	A1W27	13	A1XF5	9
A1S1H1	11	A1W28	13	A1XF6	9
A1S1H2	11	A1W29	13	MP1	5
A1S2	11	A1W3	8	MP1MP1	5
A1S2	11	A1W3P5	8	MP1MP1H1	5
A1S2H1	11	A1W30	13	MP1MP1H2	5
A1S2H2	11	A1W31	13	MP1MP1H3	5
A1S3	11	A1W32	13	MP1MP2	5
		A1W33	14	MP1MP2H1	5

SECTION IV INDEX-REFERENCE DESIGNATION CROSS-REFERENCE TO PAGE NUMBER (CONTINUED)

REFERENCE DESIGNATION	PAGE NO	REFERENCE DESIGNATION	PAGE NO	REFERENCE DESIGNATION	PAGE NO
	5	MP2A1A1E3	19	MP2A1A1XDS13	18
	5	MP2A1A1E4	19	MP2A1A1XDS14	18
	5	MP2A1A1E5	19	MP2A1A1XDS15	18
	5	MP2A1A1E6	19	MP2A1A1XDS16	18
	5	MP2A1A1E7	19	MP2A1A1XDS17	18
	5	MP2A1A1E8	19	MP2A1A1XDS2	18
	5	MP2A1A1E9	19	MP2A1A1XDS3	18
	16	MP2A1A1H1	17	MP2A1A1XDS4	18
	16	MP2A1A1H2	17	MP2A1A1XDS5	18
	16	MP2A1A1J1	19	MP2A1A1XDS6	18
	17	MP2A1A1J1H1	19	MP2A1A1XDS7	18
	18	MP2A1A1J1H2	19	MP2A1A1XDS8	18
	18	MP2A1A1J1H3	19	MP2A1A1XDS9	18
	18	MP2A1A1J2	19	MP2A1MP1	19
	18	MP2A1A1J2H1	19	MP2A1MP1H2	20
	18	MP2A1A1J2H2	19	MP2A1MP1MP1	19
	18	MP2A1A1J2H3	19	MP2A1MP1MP2	19
MP2A1A1DS2	18	MP2A1A1MP1	17	MP2A1MP1MP2H1	19
MP2A1A1DS3	18	MP2A1A1TB1	17	MP2A1MP2	20
MP2A1A1DS4	18	MP2A1A1TB1CR1	17	MP2A1MP2MP1	20
MP2A1A1DS5	18	MP2A1A1TB1E1	17	MP2A1MP2MP2	20
MP2A1A1DS6	17	MP2A1A1TB1H1	17	MP2A1MP2MP2H1	20
MP2A1A1DS7	17	MP2A1A1TB1R2	17	MP2A1MP3	20
MP2A1A1DS8	17	MP2A1A1TB1R5	17	MP2A1MP3H1	20
MP2A1A1DS9	17	MP2A1A1TB1R6	17	MP2A1MP4	20
MP2A1A1E1	17	MP2A1A1TB1R8	17	MP2A1MP4H1	20
MP2A1A1E10	17	MP2A1A1TB2	17	MP2A1MP4H2	20
MP2A1A1E11	17	MP2A1A1TB2E1	17	MP2A1MP4H3	20
	18	MP2A1A1TB2H1	17	MP2MP1	16
	19	MP2A1A1TB2R1	17	MP2MP2	20
	19	MP2A1A1TB2R3	17	MP2MP3	20
	19	MP2A1A1TB2R4	17	MP2MP3H1	20
	19	MP2A1A1TB2R7	17	MP2MP4	20
MP2A1A1E14	19	MP2A1A1XDS1	17	MP2MP4H1	20
MP2A1A1E15	19	MP2A1A1XDS10	18		
MP2A1A1E16	19	MP2A1A1XDS11	18		5
MP2A1A1E17	19	MP2A1A1XDS12	18		5
MP2A1A1E2	18				



ASSEMBLY 1 FIGURE 1

USABLE ON CODE A

EL6625-820-40P-1

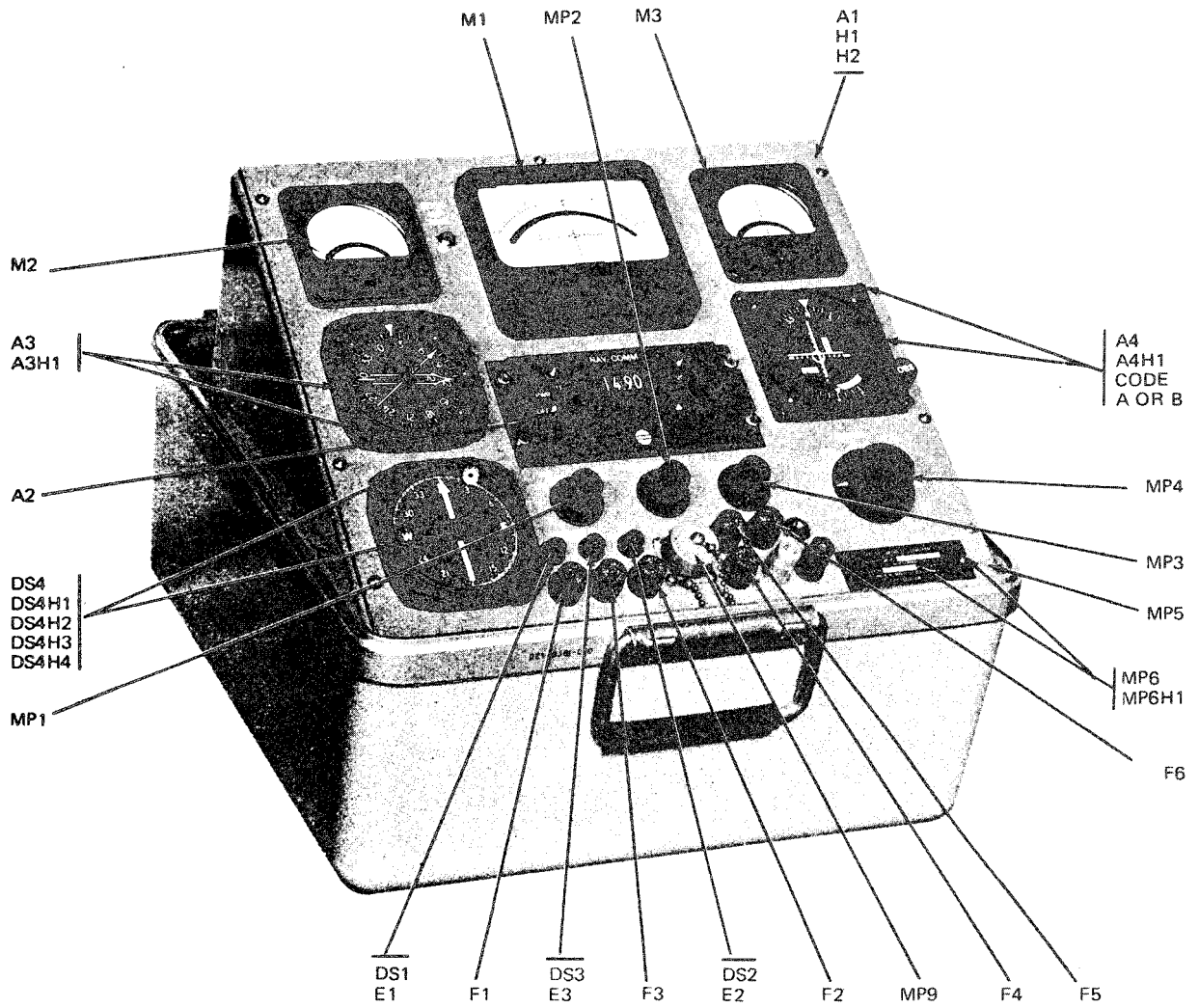

USUABLE ON CODE A AND B FIGURE 2

EL6625-820-40P-2

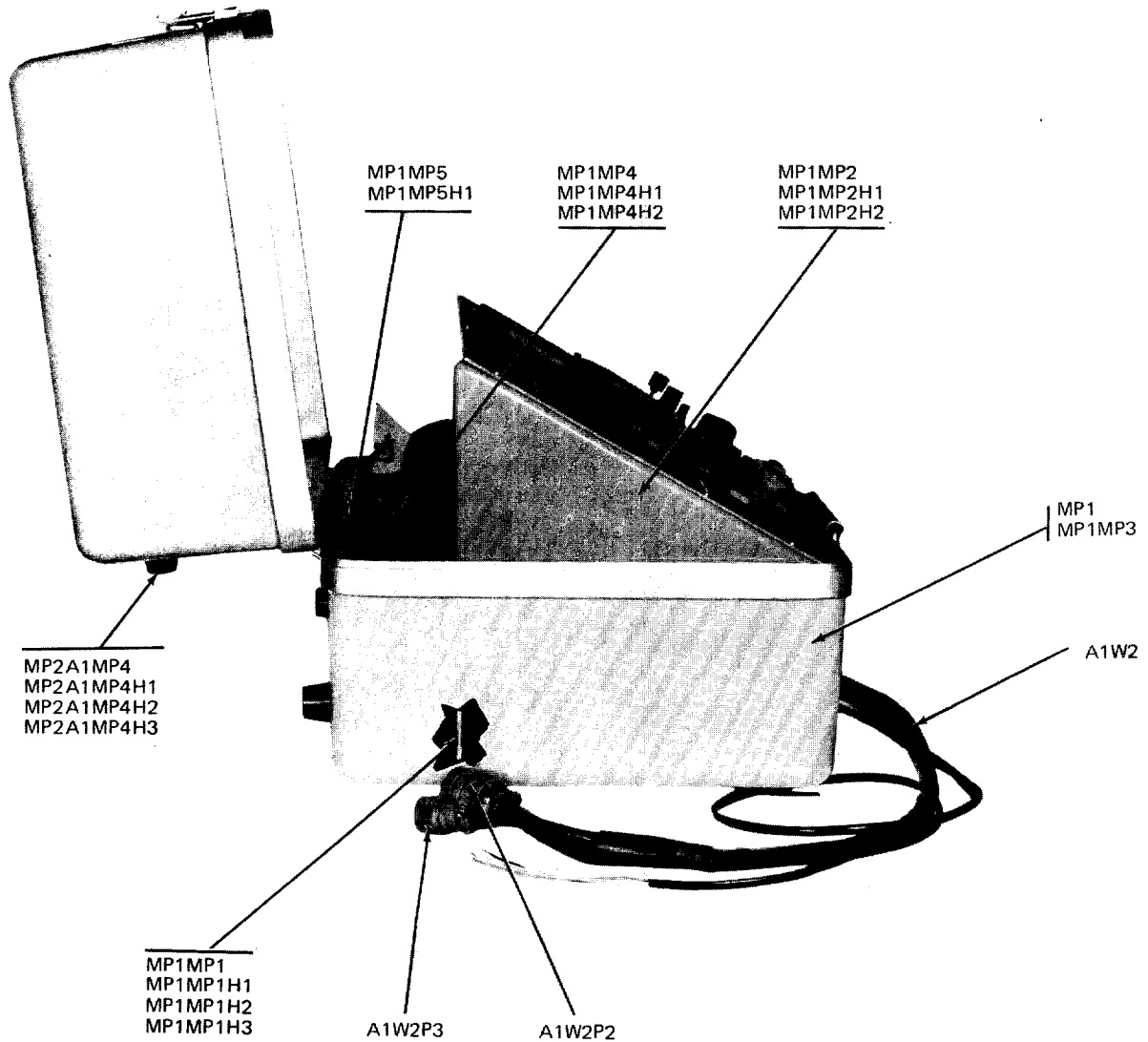

ASSEMBLY 1 FIGURE 3

EL6625-820-40P-3

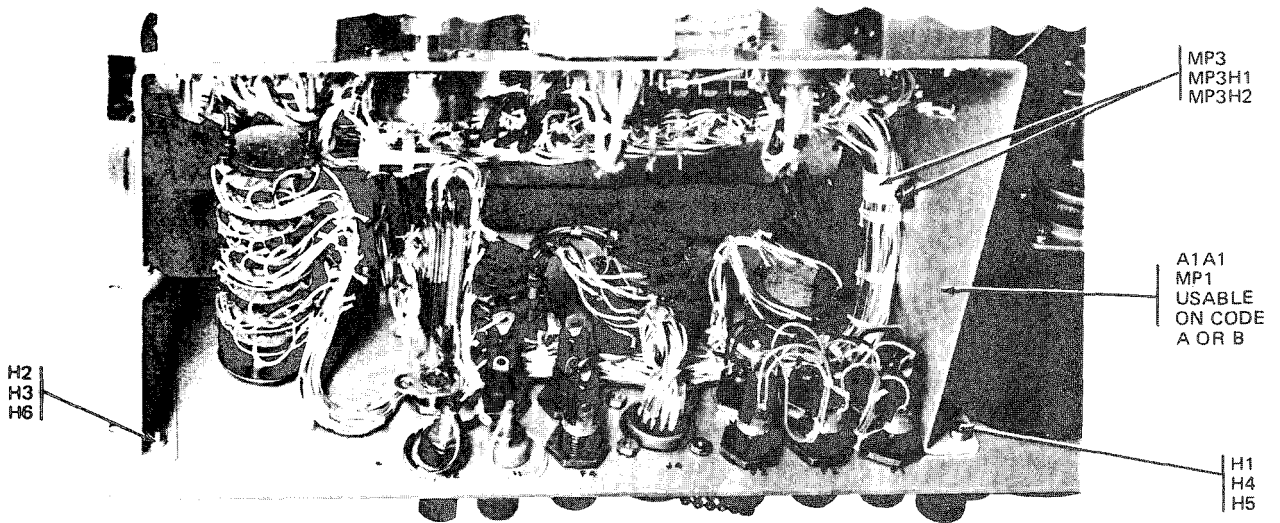

ASSEMBLY A1A1 FIGURE 4

USABLE ON CODE A AND B

EL6625-820-40P-4

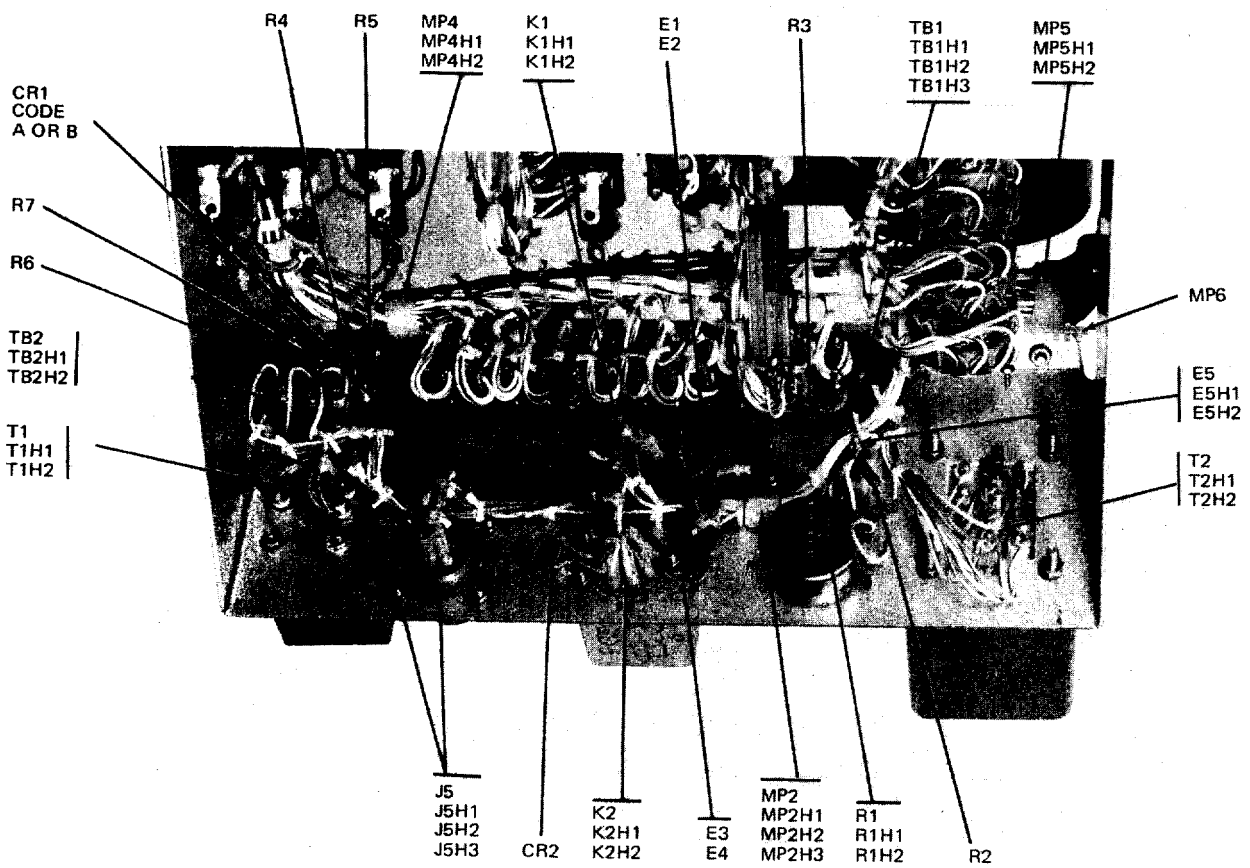

ASSEMBLY A1A1 FIGURE 5

USABLE ON CODE A OR B

EL6625-820-40P-5

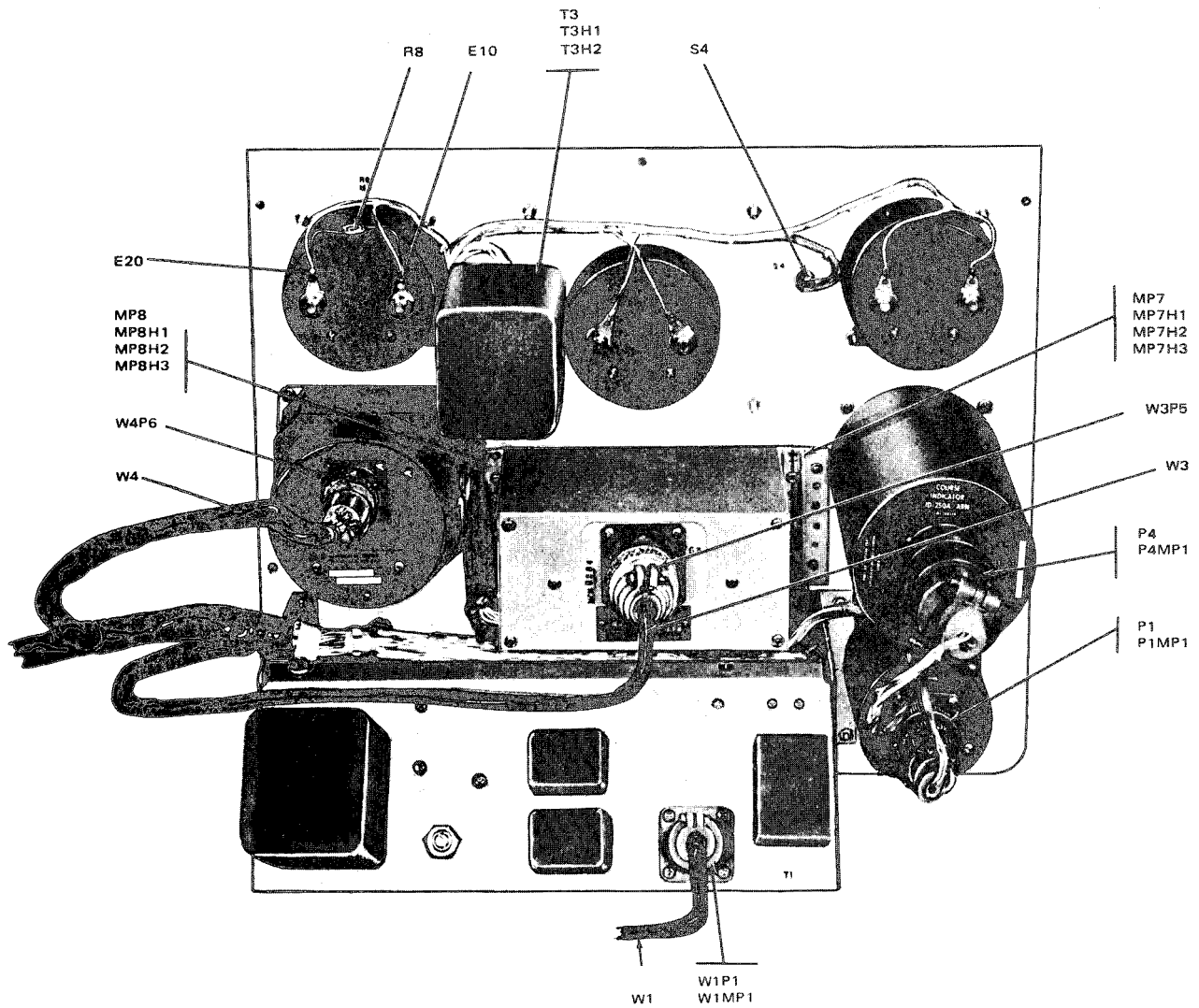

ASSEMBLY A1 FIGURE 6

EL6625-820-40P-6

J3
J3H1
J3H2

J2

XF6

J1

XF5

XF4

J4
J4H1
J4H2
J4H3
J4H4

XF2

XDS2

XF3

XDS3

ASSEMBLY A1 FIGURE 7

EL6625-820-40P-7

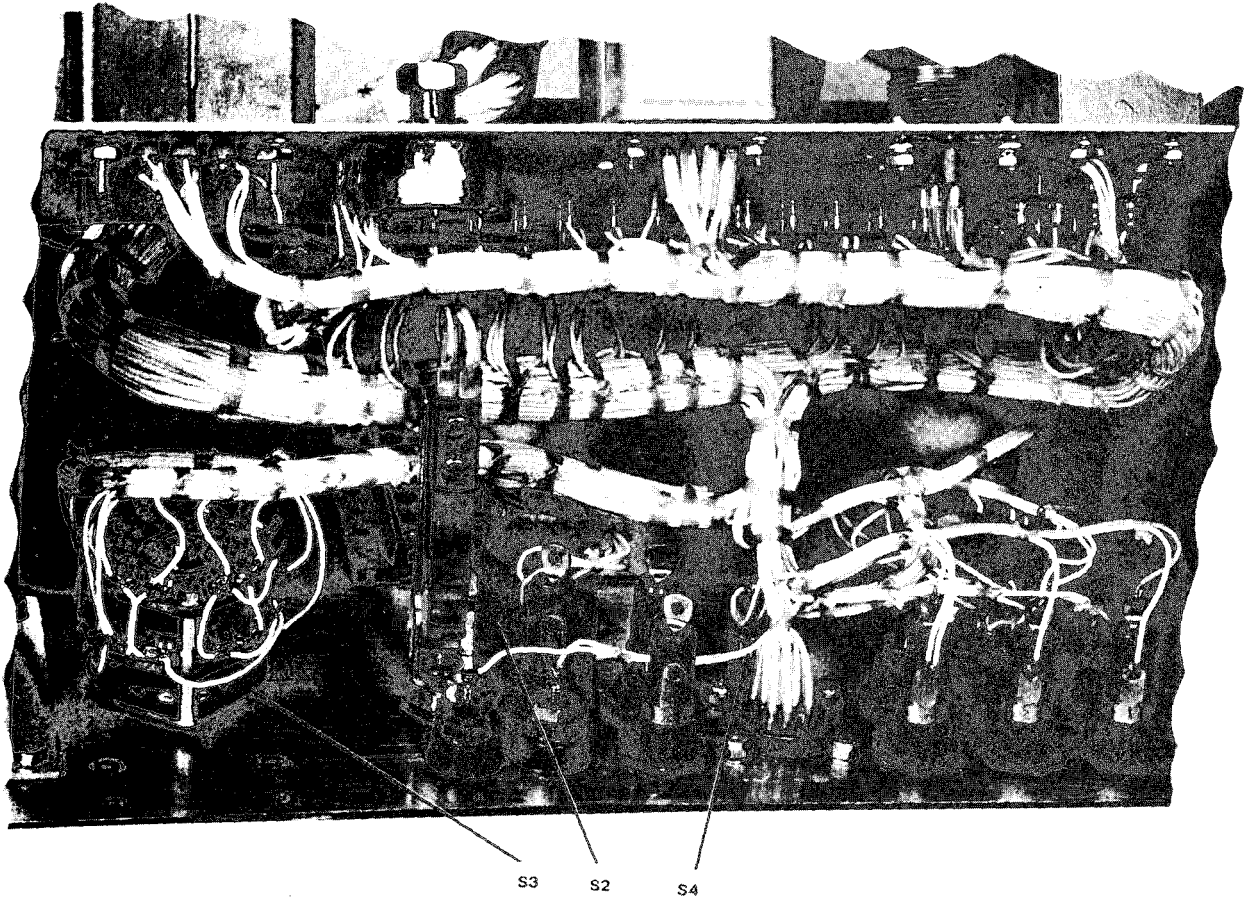

ASSEMBLY A1 FIGURE B

USABLE ON CODE A

EL6625-820-40P-8

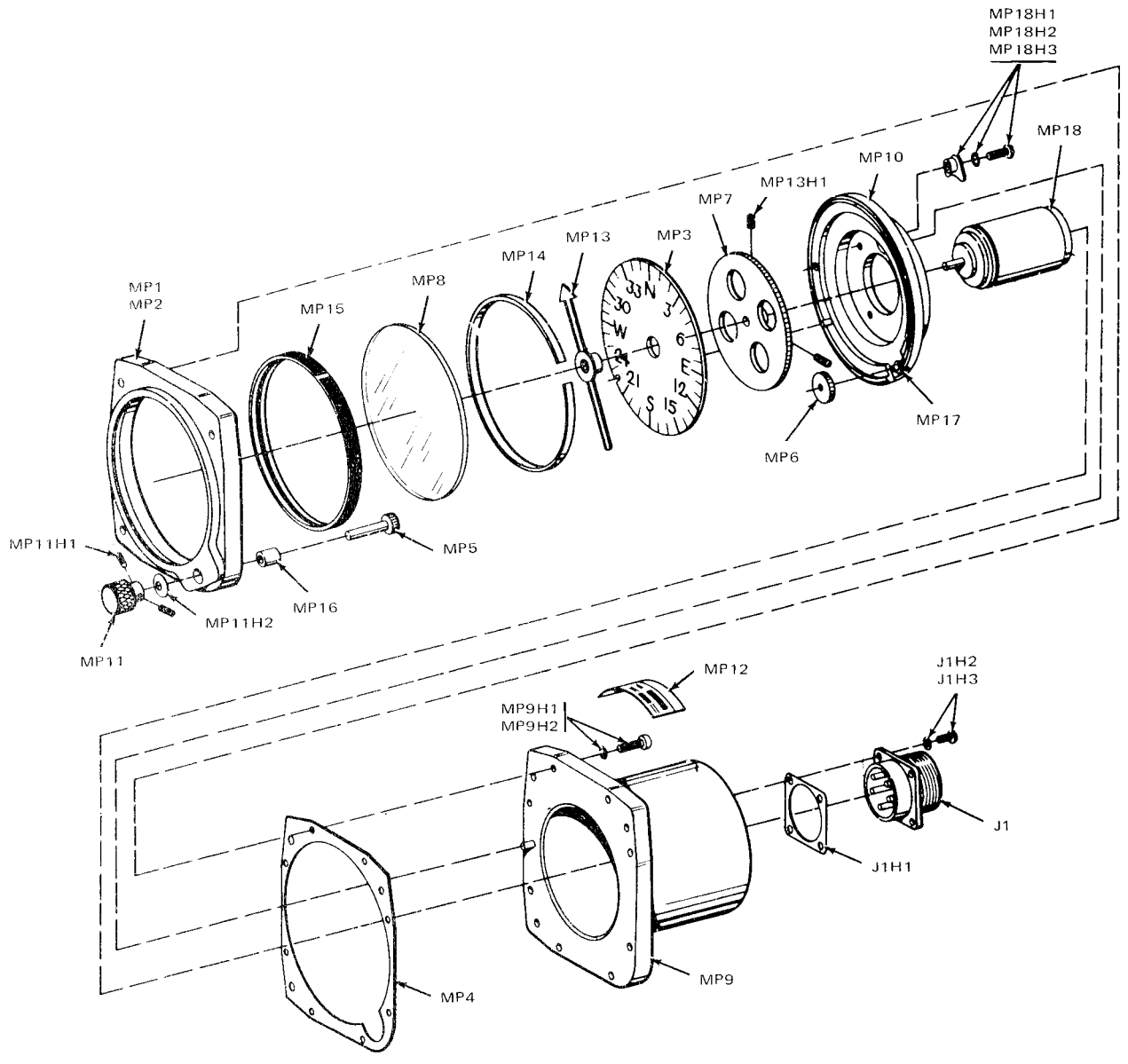

ASSEMBLY A1DS4 FIGURE 9

EL6625-820-40P-9

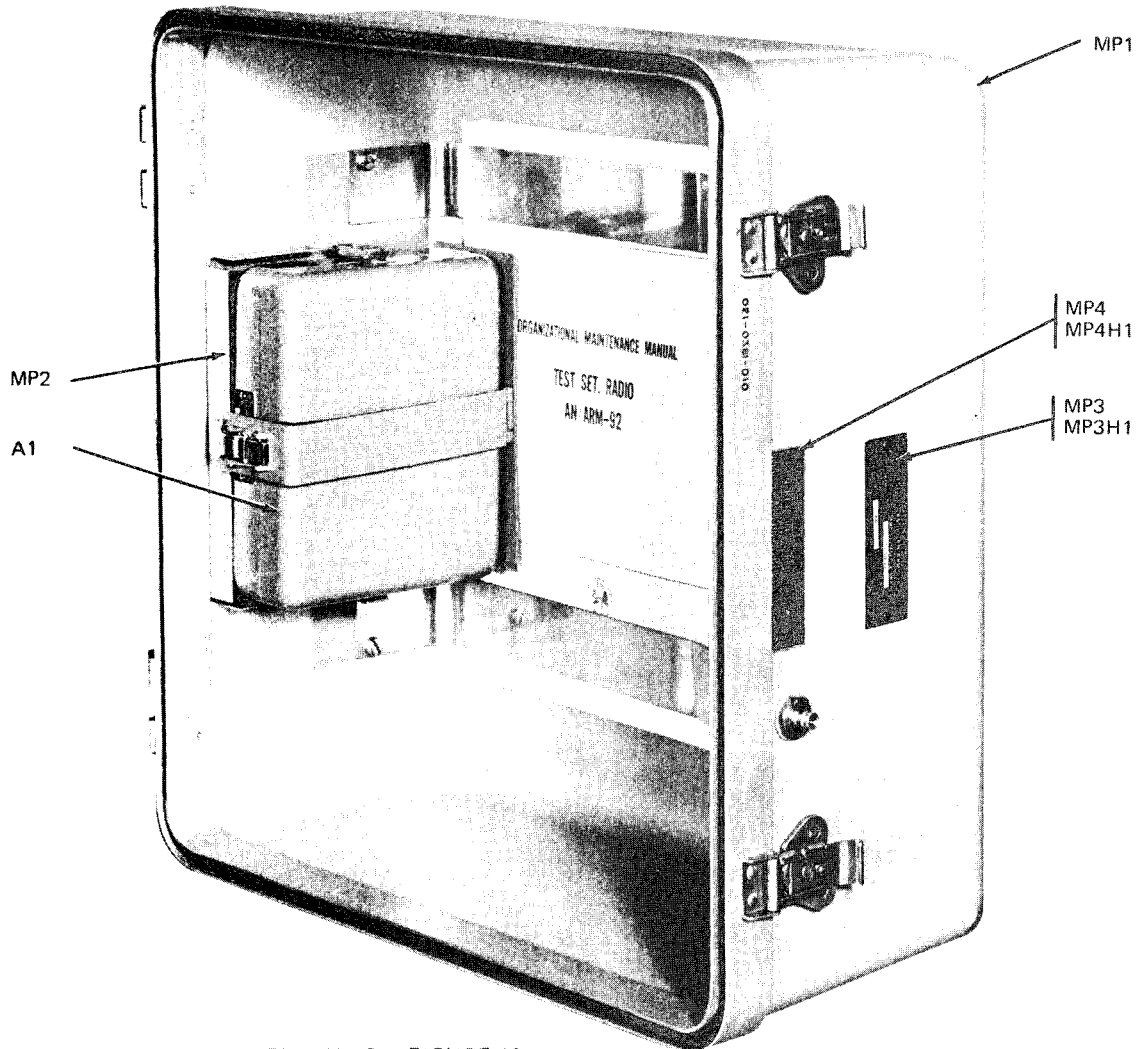

ASSEMBLY MP2 FIGURE 10
USABLE ON CODE A AND B

EL6625-820-40P-10

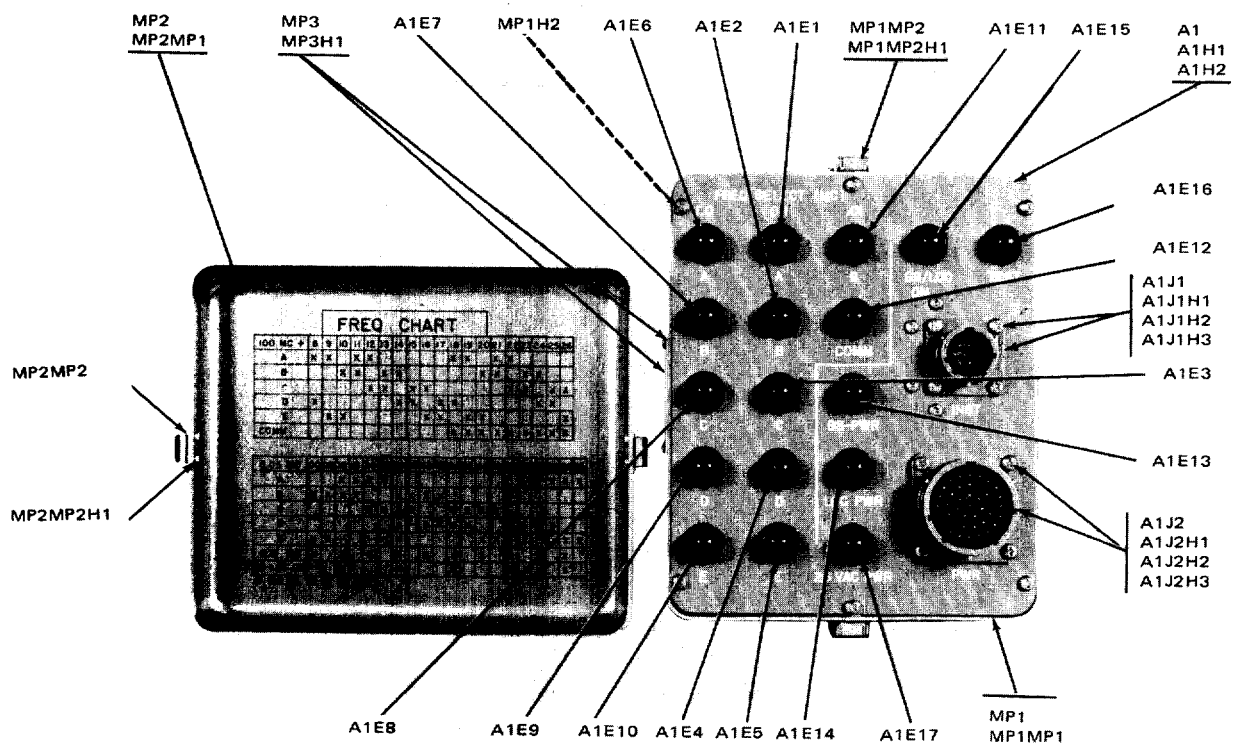

ASSEMBLY MP2A1 FIGURE 11

EL6625-820-40P-11

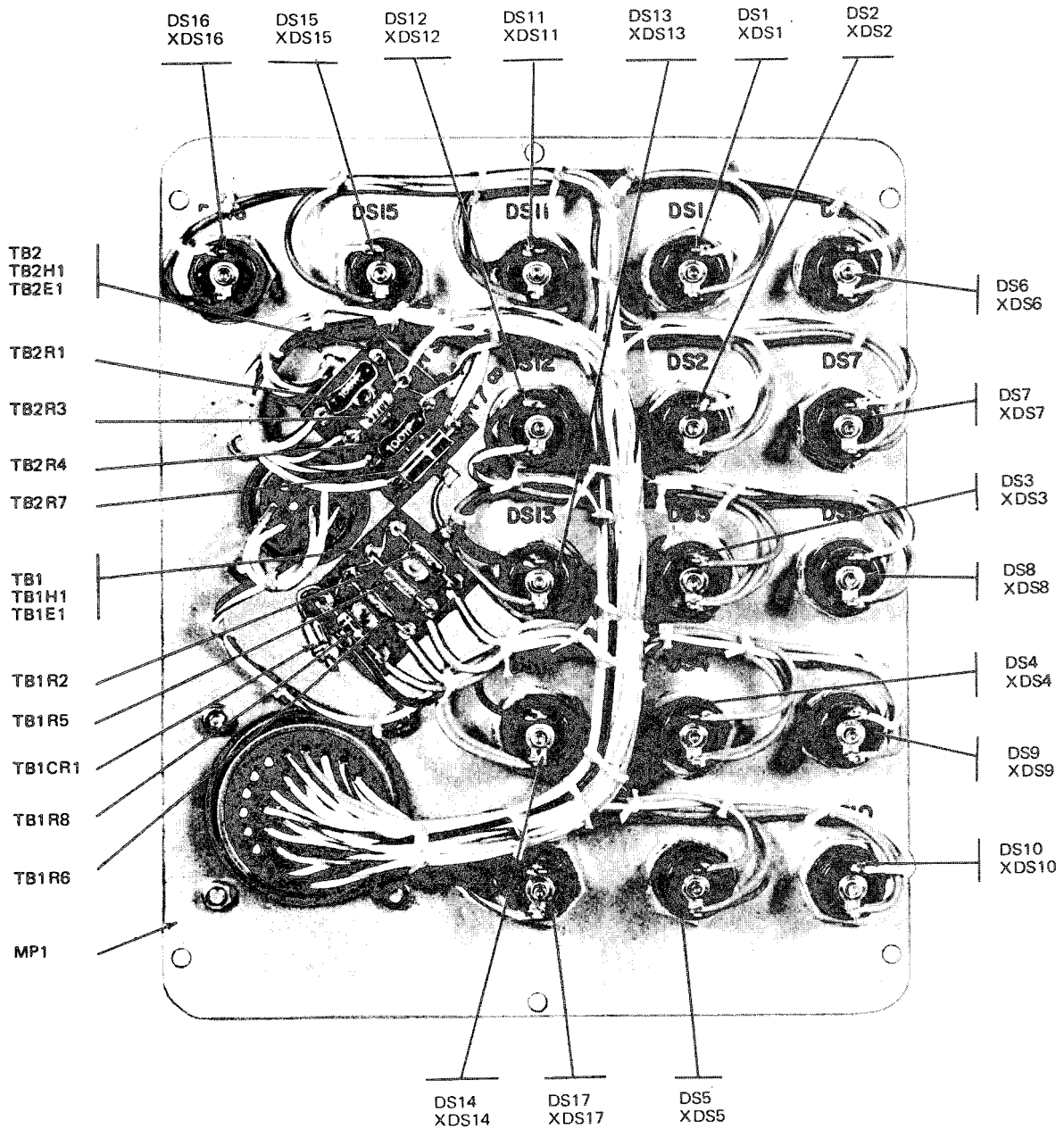

ASSEMBLY MP2A1A1 FIGURE 12

EL6625-820-40P-12

By Order of the Secretary of the Army:

CREIGHTON W. ABRAMS
General, United States Army
Chief of Staff

Official:

VERNE L. BOWERS
Major General, United States Army
The Adjutant General

Distribution:

To be distributed in accordance with DA Form 12-36A, Section II (qty rqr block No. 801) Direct and General Support maintenance requirements for AN/ARM-92.

